

**PUBLISHABLE
FINAL TECHNICAL REPORT**

CONTRACT N° : G6RDCT2002-00843

PROJECT N° : GRD1-2002-70003

VIBTOOL
*Grip Force Mapping for Characterisation of Hand-Held
Vibrating Tools*

PROJECT CO-ORDINATOR:

**UNIVERSITA' POLITECNICA DELLE MARCHE – Dipartimento di Meccanica –
Prof. E.P.Tomasini – (UNIVPM) - IT**

PARTNERS :

Consiglio Nazionale delle Ricerche – (IMAMOTER)	IT
Institut National de Recherche et de Sécurité – (INRS)	F
NOVEL GmbH – (NOVEL)	D
University of Southampton – (ISVR)	UK
Berufsgenossenschaftliches Inst. für Arbeitssicherheit - (HVBG/BGIA)	D
Breakers A/S – (BREAKERS)	DK

REPORTING PERIOD: FROM 1/12/2002 TO 30/11/2005

PROJECT START DATE: 1/12/2002

DURATION : 36 months

Date of issue of this report : 31st January 2008



**Project funded by the European Community
under the 'Competitive and Sustainable
Growth' Programme (1998-2002)**

Table of contents

TABLE OF CONTENTS	2
EXECUTIVE SUMMARY	3
OBJECTIVES OF THE PROJECT	4
SCIENTIFIC AND TECHNICAL DESCRIPTION OF THE RESULTS	5
WP 0: PROJECT MANAGEMENT AND COORDINATION	5
Objectives	5
Description of WP0	5
WP 1: DEVELOPMENT OF POLYMERIC CAPACITIVE SENSOR MATRICES.	7
Objectives	7
Scientific and technical description of WP1	7
WP 2: DEVELOPMENT OF INSTRUMENTED GLOVE	10
Objectives	10
Scientific and technical description of WP2	10
WP 3: EVALUATION AND REFINEMENT OF SENSOR ELECTRONICS AND SOFTWARE.....	12
Objectives	12
Scientific and technical description of WP3	12
WP 4: METROLOGICAL ANALYSIS OF SENSOR CAPACITIVE MATRICES.	14
Objectives	14
Scientific and technical description of WP3	14
WP 5: METROLOGICAL ANALYSIS OF INSTRUMENTED GLOVE.....	22
Objectives	22
Scientific and technical description of WP5	22
WP 6: TEST OF SENSORS IN LABORATORY CONDITIONS.	26
Objectives	26
Scientific and technical description of WP6	26
WP 7: TESTS OF SENSORS AT TYPICAL WORKPLACE.....	43
Objective	43
Scientific and technical description of WP7	43
WP 8: TESTS OF SENSORS FOR ERGONOMIC AND MEDICAL APPLICATIONS.	51
Objective	51
Scientific and technical description of WP8	51
Objective	58
Scientific and technical description of WP3	58
COMMUNITY ADDED VALUE AND CONTRIBUTION TO EU POLICIES	64
EUROPEAN DIMENSION OF THE PROBLEM	64
CONTRIBUTION TO DEVELOPING S&T CO-OPERATION AT INTERNATIONAL LEVEL. EUROPEAN ADDED VALUE	64
CONTRIBUTION TO POLICY DESIGN OR IMPLEMENTATION	64
CONTRIBUTION TO COMMUNITY SOCIAL OBJECTIVES	64
IMPROVING THE QUALITY OF LIFE IN THE COMMUNITY:	64
PROVISION OF APPROPRIATE INCENTIVES FOR MONITORING AND CREATING JOBS IN THE COMMUNITY (INCLUDING USE AND DEVELOPMENT OF SKILLS):	65
SUPPORTING SUSTAINABLE DEVELOPMENT, PRESERVING AND/OR ENHANCING THE ENVIRONMENT (INCLUDING USE/CONSERVATION OF RESOURCES):	65
RESULTS AND CONCLUSIONS	66
REFERENCES	67
ACKNOWLEDGEMENTS	68

EXECUTIVE SUMMARY

The main scientific objective of VIBTOOL was to improve repeatability and reproducibility of vibration tests carried out on hand-held power tools by means of arrays of polymeric capacitive pressure sensors used to monitor contact force and pressure, which are known to be influencing parameters.

Scientific and technological objectives of the project were:

- 1) to develop sensors to measure grip and push force and contact pressure distribution for hand-held tools in the form of:
 - matrices to be wrapped on the handle,
 - instrumented gloves;
- 2) to perform a thorough metrological analysis of their performance, in terms of static and dynamic characteristics for direct pressure measurement and for indirect force measurement;
- 3) to perform tests on different types of hand-held tools according to existing norms and with the monitoring of grip and push force, correlation analysis aimed to verify if dispersion of results can be reduced by monitoring and controlling grip and push force during tests;
- 4) to evaluate results for standardisation purposes;
- 5) to explore possible application of these sensors for ergonomic and medical studies.

The main project results obtained by the Consortium were:

- 1) design and realization of three different polymeric matrices of capacitive pressure sensor with adequate compliance and sensitivity
 - a square matrix prototype of 16 X 16 over a sensing area 125x125 mm;
 - a finger-matrix prototype of 12x12 sensors arranged in the palm-finger area over a surface 125.52x125.52 mm, plus a separated set of 3x4 sensors arranged in the thumb area over a surface 41.84x31.38 mm
 - high spatial-resolution sensor matrix with 25 X 25 sensors arranged in a Cartesian grid over 125x125 mm.
- 2) an instrumented glove;
- 3) data acquisition hardware/software and data processing algorithms to measure grip and push actions by the finger-matrix;
- 4) new improved definitions of grip and push actions;
- 5) a large series of experiments on various tools with several operators:
 - in laboratory conditions
 - in real field tests;
- 6) a proposal for improvement of the ISO-DIS-15230 standard on measurement of grip and push forces on handles which has been presented to CEN and ISO and has been discussed with representatives of national standardization bodies.

Objectives of the project

The main objective of the VIBTOOL project is to develop a measurement system for contact pressure distributions between hand and tool-handle. Such system is explicitly intended to be a system useful to measure coupling forces during tool testing; therefore, in case of success, it has a direct impact on standardization, being well recognized that the measurement of coupling forces during type tests of tools and during evaluation of vibration exposure of operators is an open issue which requires a solution.

Therefore the main focus of the VIBTOOL consortium has been on the development and validation of the prototypes of the system and on the proposal of such an approach to CEN-TC231 and to ISO which is now developing a standard for coupling force measurements (*Proposal for the draft standard ISO/DIS 15230-Definitions and guidelines for the measurement of the coupling forces for operators exposed to hand-arm-vibration*). Parallel to this, the sensors have been employed for the study of biodynamic and physiological effects of contact force and pressure.

This research has a potential impact on a large number of end users; it is estimated that about 24% of European workers is exposed to mechanical vibrations at some level (*2nd European Survey on Working Conditions-Dublin, 1996; European Agency for Safety and Health at Work-Bilbao, 2000*).

The research has a relevant impact also on tool manufacturers (an industry that in Europe produces several million tools per year); in fact this industry suffers from a severe lack of repeatability and reproducibility in tool testing, which may be reduced in case of full success of the project.

The project has an impact also in view of the new European Directive 2002/44/CE on Vibrations which is now entering into force.

Therefore VIBTOOL has a strong and relevant impact on working conditions, safety at the workplace and on the related norms and standards.

It is important to highlight that the sensor manufacturer is an SME; this company has been developing capacitive sensing technology for contact pressure measurement since two decades in the field of biomechanics of the foot and now is entering through the VIBTOOL project into the field of hand-held tools. They are strongly interested into this new field, because of the economic potential that could arise from a successful research project and from the acceptance of such an approach at ISO level. Such a perspective could not have been opened without the complementary expertise and efforts of the partnership of the VIBTOOL project and therefore it is recognised that the financing of this research will have a very positive impact on one of the involved SME.

Scientific and technical description of the results

In the following the scientific and technical description of the activity will be reported for each workpackage (WP).

WP 0: Project management and coordination

Workpackage Manager: UNIVPM; Partners involved: UNIVPM, ISVR and NOVEL.

Objectives

An effective and coherent project management has been provided in order to ensure:

- project progress with technical coherence and quality,
- timely delivery of results,
- continuous performance of all partners;
- exploitability of the project outcome beyond the project,
- to create awareness among both scientific community and industry, and to contribute to the published scientific state of the art.

Description of WP0

Contacts with the EU Officer and management of the project have been carried out by the Project Coordinator UNIVPM. Management has been subdivided into financial/administrative, technical/scientific, and exploitation management. For Technical/scientific and exploitation management, the coordinator UNIVPM (a university) has been backed mainly by NOVEL (a company).

- Financial/administrative management.

UNIVPM coordinated and planned all the activities related to the organisation (incl. Meetings preparation and minutes); financial management; progress reports; maintaining contact with the Commission and with related projects. Care was paid so to stimulate a cooperative mood among partners. All partners have demonstrated a positive collaboration and participated actively to the project activities.

- Project Presentation:

A publishable project presentation has been prepared by UNIVPM (the content has been approved by the Consortium).

- Dissemination:

Each Partner had contributed to the dissemination of the scientific activity during the project. Some publications at conferences have also been prepared.

All information related to the project has been circulated among partners by e-mail and by an extensive use of a dedicated web-site, realised by UNIVPM, (the VBTOOL project web-site is <http://mm.univpm.it/vibtool>). This web-site has an open public area for general information on the project, while a second restricted area is used by the partners for sharing internal information.

Several students were involved in the project activities; 4 students did their final project on topics related to the VIBTOOL project. Furthermore, some seminars and classes on the subject have been given to undergraduate and graduate university students by the university partner UNIVPM.

A large effort has been done to bring relevant information on project results to the attention of CEN; this is particularly important for this project, which was financed under a dedicated call for proposals in

support to standardization. CEN officers have been informed by e-mail and personal contacts of partners, during all the project, about progress achieved and plans of activity. Then, having identified that a new draft standard was being developed by ISO and was being voted by CEN and European standardization bodies, a direct contact to the relevant Technical Committee, namely CEN-TC-231 Mechanical Vibrations and shock has been established, so to discuss the influence of VIBTOOL project results on the standard draft *ISO-DIS-15230 Mechanical vibration and shock — Coupling forces at the machine-man interface for hand-transmitted vibration*. The Coordinator UNIVPM and two of the partners (INRS and HVBG/BGIA/BGIA) have participated to the annual CEN-TC-231 meeting and a resolution has been taken after the VIBTOOL project presentation. The Resolution 3/2005 taken by CEN/TC 231 on 2005-10-19 says that:

Subject: CEN/TC 231 – VIBTOOL-Project, CEN/TC 231 "Mechanical vibration and shock", — having considered the new information in the presentation of the VIBTOOL-Project by Prof. Paone and having noted ISO/DIS 15230:2005 "Mechanical vibration and shock — Coupling forces at the machine-man interface for hand-transmitted vibration", which has been circulated to ISO/TC 108/SC 4 members for voting by 2006-02-20, decides to ask its members to take into account the results of the VIBTOOL-Project when voting on the DIS.

The decision was taken by unanimity. This action is a very relevant dissemination of results towards standardization that the VIBTOOL consortium has successfully done; all management efforts directed to this goal resulted successful.

- Development of business plan:

Some important companies selling industrial vibrating tool have demonstrated their interest in the possibility to use the technology developed in the project for their research projects. This has led NOVEL to plan a business activity on the outcome of the project. The industrial partner (NOVEL) has indeed already put on the market the special pressure matrices developed in the project, which by 2006 will be a commercial product. The Technology Implementation Plan-TIP reports on this issue.

- Technical management:

Technical activities have been monitored during the all project by the Project Manager and, when necessary, discussed with the other partners. All WPs have been coordinated in close cooperation with the WP leader; delays were monitored and rescheduling of activities has allowed the management of technical difficulties met throughout the project. When necessary, UNIVPM, has provided additional manpower as well as instrumentation (this happened towards BREAKERS, INRS, HVBG/BGIA/BGIA and CNR-IMAMOTER) to support the technical activities and to maximise the outcome of the project.

- Exploitation management:

Continuously monitoring of project outcome to ensure exploitability of what developed and possible contribution to new standards has been carried out throughout the project.

Direct contacts with CEN-TC 231 Mechanical Vibration and Shock have been established, in order to promote exploitation of results for support to normative on hand-arm vibration, with particular reference to ISO-DIS-15230. A presentation to the annual TC-231 meeting has been made by the coordinator and some partners, to promote the use of the results by standardization bodies. This has resulted in a proposal to improve a standard draft on measurement of coupling forces between hand and arm.

WP 1: Development of polymeric capacitive sensor matrices.

Workpackage Manager: UNIVPM; Partners involved: UNIVPM, ISVR and NOVEL.

Objectives

WP1 objectives was the design and development of a sensor matrix which could be mounted on the handle of a tool and measure directly contact pressure distribution and indirectly to measure grip and push forces.

Scientific and technical description of WP1.

The research activity concerning WP1 has been conducted by UNIVPM in close collaboration with NOVEL (and with some support of HVBG/BGIA) with the aim to study an optimized design for the matrix. The first year saw the development and production of a first sensor matrix prototype, the definition of the hand/handle contact area and the optimisation of the hand sensor matrix layout in order to overcome the difficulties in applying the matrix to complex ergonomic handle. The final sensor matrix (acronym: FINGERMAT) was produced during the second year of the project and delivered during 20th month. During the third year of the project, upon consortium request, NOVEL produced an extra matrix with a higher sensor resolution for the validation of the FINGERMAT.

The work package began with the idea of improving an existing sensor prototype. Such first sensor prototype was developed during the previous European project: DOPTTEST, contract Nr. SMT4-CT97-2181. Matrix thickness, elasticity and sensor dimensions have been highlighted as important parameters for the matrix applicability to ergonomic handles. New researches and developments were carried out by NOVEL in the directions of a new design and handling of the elastomer to decrease the overall thickness and trying to maintain the mechanical characteristics of the transducer. The studies led to the production of a first prototype of the sensor matrix (acronym S2022) with the same layout of the DOPTTEST matrix (fig.1), but a wider pressure range, up to 300kPa, and a reduced overall thickness of 0.7mm. A first prototype has been delivered to UNIVPM by NOVEL during the 3rd month of the project. The synthetic leather coating material used during the DOPTTEST project to protect the matrix has been replaced with a new material capable of better preserving the elasticity of the transducer. A market study brought NOVEL to consider for its robustness, elasticity, biocompatibility and water proof peculiarity, a polyurethane material extruded into 200µm thick film as the best choice for the project application.

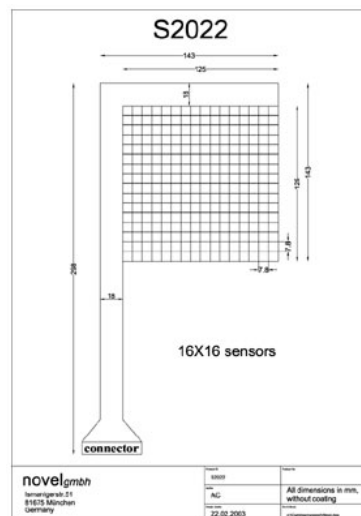

Figure.1 Layout of the first prototype sensor matrix S2022.

A special experimental set-up has been realised for the evaluation of hand-matrix contact area. The knowledge of the effective contact area between hand and matrix could allow to choose an optimised

location for the sensors on the matrix (depending on probability of contact between hand and matrix). Results have been used for the calculation of the distribution of the probability of the contact, results are reported in figure 3.

Different lay-outs for the matrices have been discussed. The proposed solutions aim to obtain a sensor matrix where sensors are only placed where the hand is in contact with the handle. The proposed lay-outs have been obtained considering results reported in figure 3. These lay-outs have been subsequently analysed by NOVEL's designer in consideration of the possible hardware limitations (cable length, sensors dimensions, etc.). The final version of the matrix design is reported in the following and it has separate fingers so to allow a better compliance with ergonomic handle different from the cylindrical.

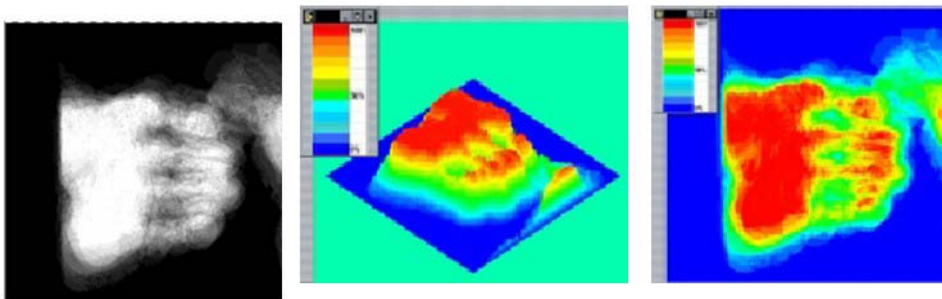

Figure 3 – Distribution of the probability of the contact.

The results of the activity and the analysis of possible handle shapes and sizes led to the proposal of a new sensor layout as shown in fig.4.

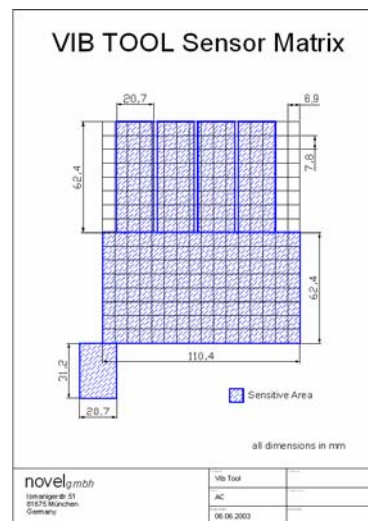

Figure.4 Proposed layout for the final sensor matrix.

The idea was to create 4 sensitive strips for accommodating the index finger, the middle finger, the ring finger and the little finger. The strips are free on one side and connected to the matrix-palm area on the other side. The sensitive area on the very bottom left side is for mapping the thumb finger. The problem of what could be realised and how, highlighted the limitation of the screen printing technology used at that time by NOVEL for the sensor development and led to the investigation of other technologies available today. An electrical layout has been designed at the beginning of the second year of the project. Taking into account the constrains of the screen printing technology, a new electrical layout has been designed Fig.5. Compared to the first sensor matrix prototype (sensor element size 8mmx8mm), this layout shows a lower sensor resolution (sensor element size 10.46mmx10.46mm). Nevertheless it is still possible to create 4 independent strips to accommodate the operator fingers and to better adapt the matrix to most contoured handles of vibrating tools. In the light of a more stable and easier structure to be realised, the consortium accepted to modify the final sensor matrix as shown in Fig.5. The final sensor

matrix, known with the acronym Fingermat, has been produced. For the production of the Fingermat has been used the same elastomer used for the “first sensor matrix” and the polyurethane coating material investigated during the first year of activity of the project.

Limited space-sensor resolution, bending of the sensor, friction, angular resolution, gradient of pressure across the contact area, were considered as possible elements which may affect the results.

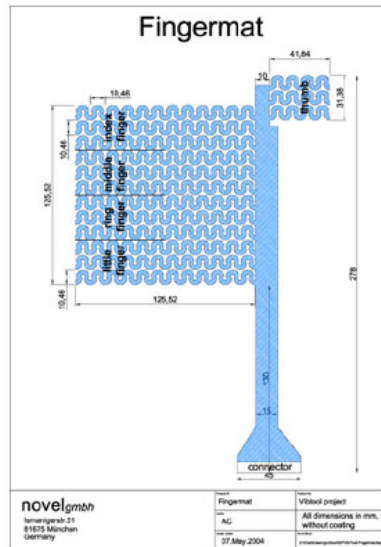

Figure.5 Schematic drawing of the final sensor matrix: Fingermat.

WP 2: Development of instrumented glove.

Workpackage Manager: INRS; Partners involved: INRS, ISVR and NOVEL.

Objectives

Main aim of WP2 was to design an instrumented glove covered with capacitive sensors able to measure the contact pressure at the interface between the hand and the tool handle. Such a measuring system should be an instrument able to assess grip and push forces.

Scientific and technical description of WP2.

WP2 aimed at designing a glove with capacitive sensors in order to measure the contact pressure between the hand and the tool handle. Such a measuring system would enable the measurement of the contact pressure mapping, and then, with numerical computing, the assessment of both gripping forces and push forces (=coupling forces). They all are significant parameters in the transmission of vibration through the hand-arm system. WP2 included a metrological analysis to characterize the glove sensor performance. Static and dynamic tests were carried out to check if it was possible with pressure integration to compute the correct coupling forces. As a result of these tests, new technical specifications were worked out and forwarded to the partner NOVEL in order to design a new prototype of glove. Although the laboratory tests showed that it was possible to assess the coupling forces and because some technical problems remained unsolved (for instance the angle capturing method) the glove was not used in the final series of field tests. Unfortunately, to our knowledge, the cyber gloves available in the market are not sufficiently reliable to ensure accurate measurements of the joint angles, especially at the CarpoMetaCarpal joint. In any case, further developments would have been necessary to model the deformation of the soft human tissues in contact with the handle, in order to compute the angles of the individual sensors. On the other hand, the approach of WP1, consisting in using flexible matrices wrapped around the handles, instead of using sensors in the shape of a glove, led to better results in terms of ergonomics constraints. So, the decision was made among all VIBTOOL participants to concentrate on the FINGERMAT sensor matrix developed in the project by UNIVPM and NOVEL within WP1.

Technical specifications and production of a new pressure glove

Complementary measurements were performed to estimate the palm width of 4 male subjects. 4 subjects were asked to grip, as strongly as they could, a handle wrapped with a square matrix of capacitive sensors. The number of sensors activated by the grip helped us to estimate the minimal width required.

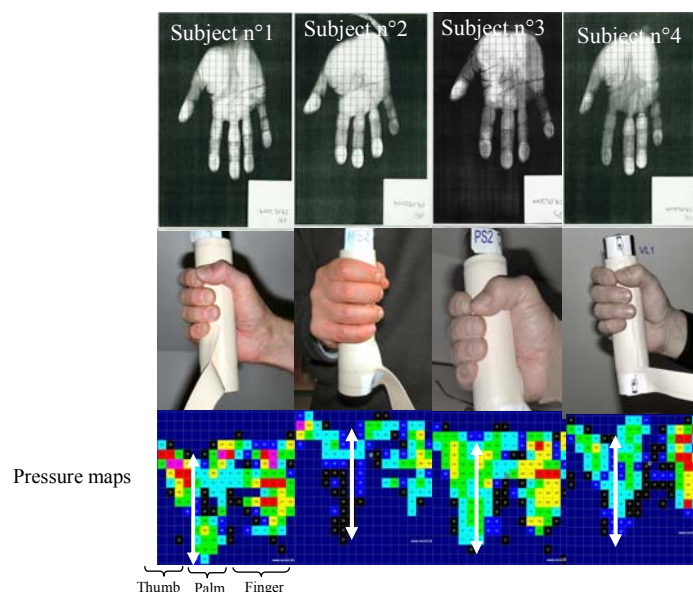

Fig. 1: determination of the minimal width required for the glove to map the whole contact area.

The data obtained from these measurements were then used to work out new dimensional specifications (table 2) and a new prototype of sensor glove was manufactured by NOVEL (see figure 2). In figure 3, the final version of the sensor glove prototype is reported.

Palm width	97 mm
Sensor size	11x11 mm (palm area)
	9x9 mm (fingers)
Number of sensors	168 in total

Table 2: INRS specifications

Dimensions of Hand Sensors				
		Unit	Glove I female	Glove II male
No. Of sensors			125	166
Finger (max)	length	mm	96	90
	width	mm	16	18
	gap	mm	2	6
	Element	mm ²	6 x 16	9 x 10
Thumb	length	mm	72	80
	width	mm	16	18
	Element	mm ²	like finger	like finger
Palm	length	mm	98	110
	width	mm	16	22
	gap	mm	2	2
	Element	mm ²	7 x 16	11 x 10
Total	length	mm	194	200
	width	mm	76	94

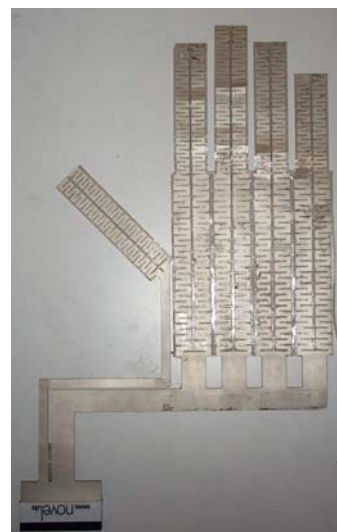

Figure. 2: dimension and view of the prototype of pressure glove produced by NOVEL

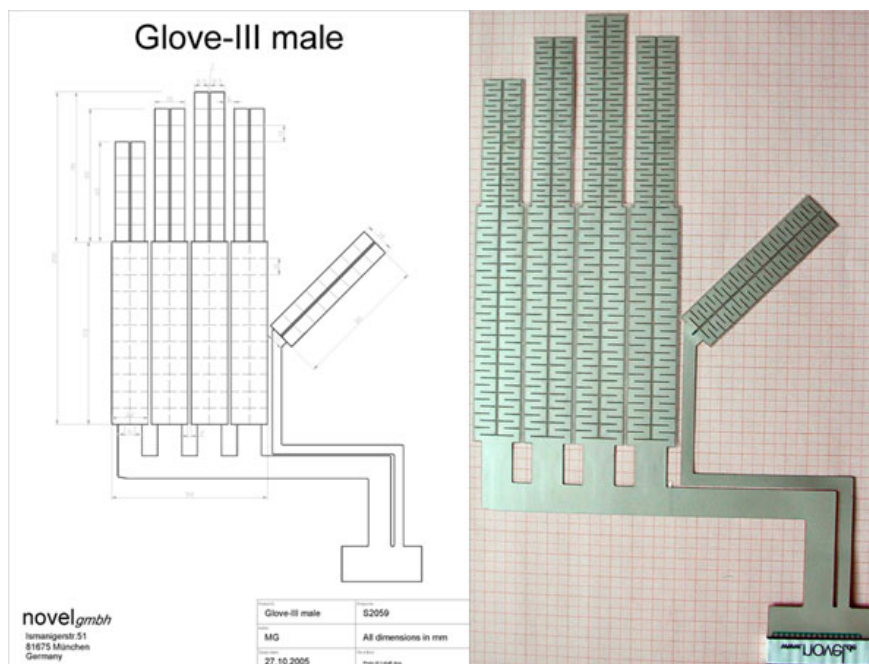

Figure 3. D2 Glove sensor: GloveIII.

WP 3: Evaluation and refinement of sensor electronics and software.

Workpackage Manager: UNIVPM; Partners involved: UNIVPM, ISVR and NOVEL.

Objectives

Aim of WP3 was to provide a complete device: sensor, hardware and software for measuring the grip force and pressure distribution at man-machine interface. Previously existing data acquisition software was adapted to specifications along with design and development of data analysis and visualisation software.

Scientific and technical description of WP3.

The activities scheduled within this WP3 were:

- development, test and provision of sensor electronics;
- development, test and provision of data acquisition software;
- definition, development, test and provision of data analysis software.

The development and test of the sensor analogue and digital electronics has been completed during the 2^o year of the project.

Three plianceX systems completed with synchronisation units, as the one shown in figure 5, have been delivered to the partners: UNIVPM, INRS and ISVR.



Figure.5: Pliance x system: software and hardware components.

Parallel to the hardware development, NOVEL progressed with the development and test of the data acquisition software. The new 32 bit software consists of 3 principal parts: the “*Settings and Calibration*” interface, the “*Configuration*” interface and the “*Measurement*” interface. The “*Settings and Calibration*” interface allows the user to define the geometry of the sensor, to set up the internal amplification and offset values for each individual sensor (to obtain the maximum possible resolution in the predetermined pressure range), to carry out the calibration procedure and create a calibration curve for each individual sensor. The “*Configuration*” interface allows the settings of time parameters (such as frequency and measurement duration), the selection between Master and Slave operation mode of the plianceX system (and relative definition of the sync signal) for synchronisation with other instrumentation, the selection of

type of buffer for data storage, the orientation of the sensor matrix on the screen according to positioning of the sensor matrix on the tool.

The “*Measurement*” interface allows the user to select between the online data acquisition mode (data are transferred from the pliance X system via Bluetooth or FOC to PC and displayed real time) and the flash data acquisition mode (data are saved on the internal 8MB memory and can be displayed after the data are transferred to PC). Furthermore in the “*Measurement*” configuration is possible to present the pressure data as 2D or 3D map, to display the time graphs of the total force, the peak pressure and contact area. Data analysis of a maximum of 16 specific region of interest, such as the palm area or the individual fingers, can be also performed. Data can be stored automatically or manually after the measurement is performed and they can be output in ascii format for further data processing.

Additional software has been developed for the creation of a database which can be configured and shaped by the partners of the consortium to include general information such as personal data of the operator under test and his clinical history, tool under test, task performed by the operator, environmental conditions at the workplace, etc.; able to connect directly to the data acquisition software and store automatically the data in the database and able to perform analysis of sensitive parameters, statistic and relational search on the collected data.

WP 4: Metrological analysis of sensor capacitive matrices.

Workpackage Manager: UNIVPM; Partners involved: UNIVPM and NOVEL.

Objectives

WP4 has been dedicated to perform static and dynamic calibration of the sensor matrices developed, to assess sensor uncertainty and to highlight sensitivity to disturbing inputs and influencing quantities.

Scientific and technical description of WP3.

The research activity was carried out by UNIVPM which designed and realised the test benches for static and dynamic calibration of the sensor matrices. The calibration tests were conducted taking in account the use of such sensors in the final configuration (wrapping on cylindrical or quasi-cylindrical handles). UNIVPM has subcontracted to Università di Perugia (UNIPG) the study of the effect of temperature on the capacitive sensors realising the matrices. UNIVPM and UNIPG have designed and realised a special cylindrical calibrator for direct calibration of wrapped matrix. The first prototype of the matrix has been utilised in the first series of tests carried out with two different models of calibrators: a plane calibrator (figure 1) and a new designed cylindrical calibrator (figure 2).

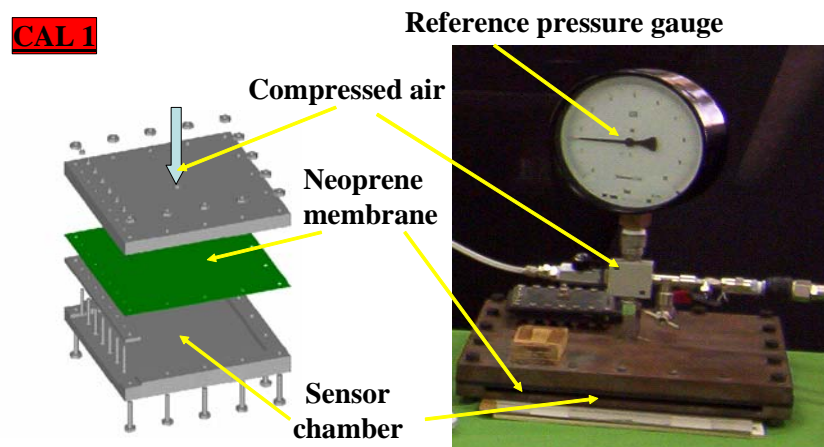

Figure 1 – Plane calibrator.

Comparison between results obtained from plane and cylindrical calibrators are reported in figure 3 for one of the 256 matrix sensors (sensor 0), during a 7-steps loading and unloading calibrating procedure (max pressure 3 bar). For both calibrators, it is clear how the loading phase is separated by the un-loading phase, this indicates the presence of hysteresis. Figure 4 and figure 5, demonstrate a reduction in the dispersion of the calibration lines when the matrix is calibrated using the cylindrical calibrator (figure 5) with respect to the procedure utilising the plane calibrator (figure 4). In the same figures, the 3σ dispersion is reported. It is also evident an increased stiffness of the sensors when the matrix is bent.

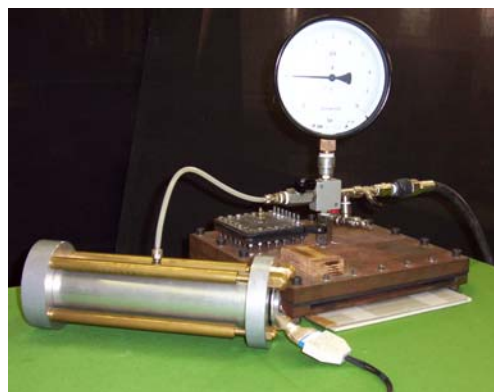

Figure 2 – Cylindrical calibrator.

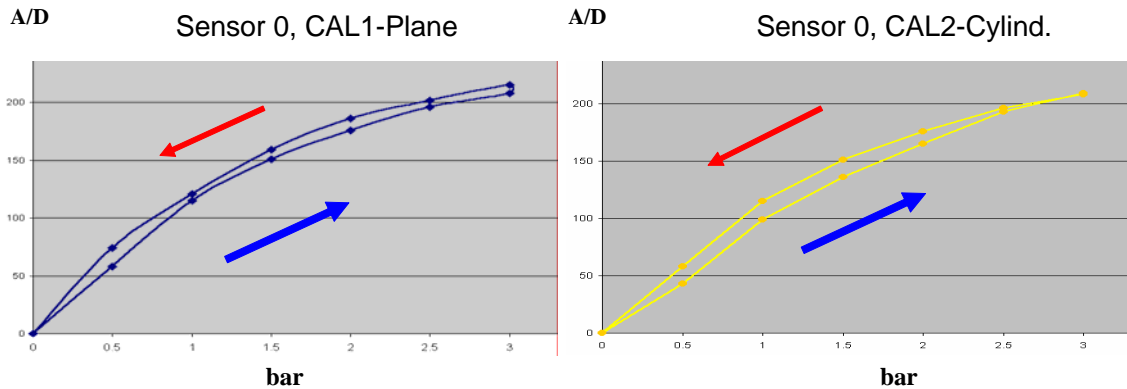

Figure 3 – Sensor 0, load-unload calibration steps.

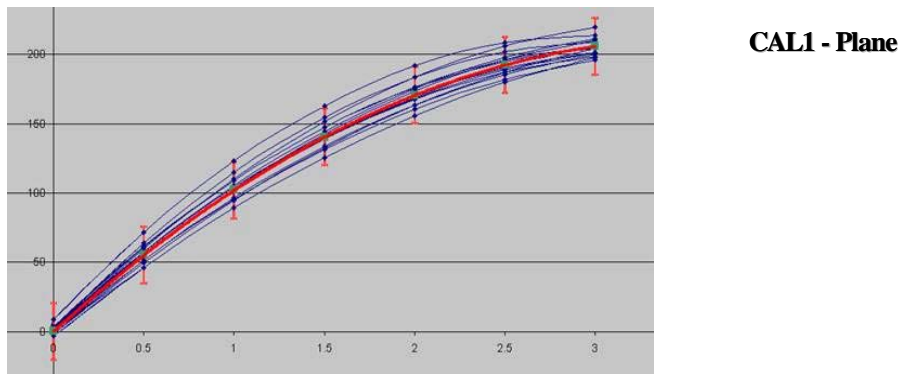

Figure 4 – Uniformity of all sensors, plane calibrator, 256 calibration lines, one single interpolator – 3σ dispersion reported.

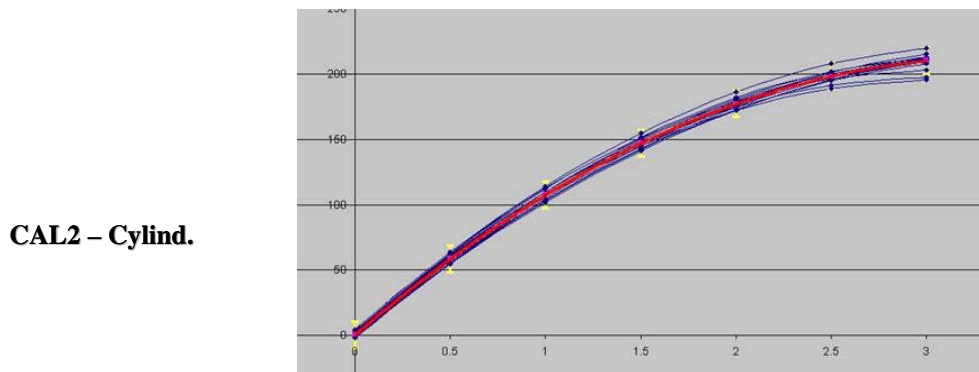
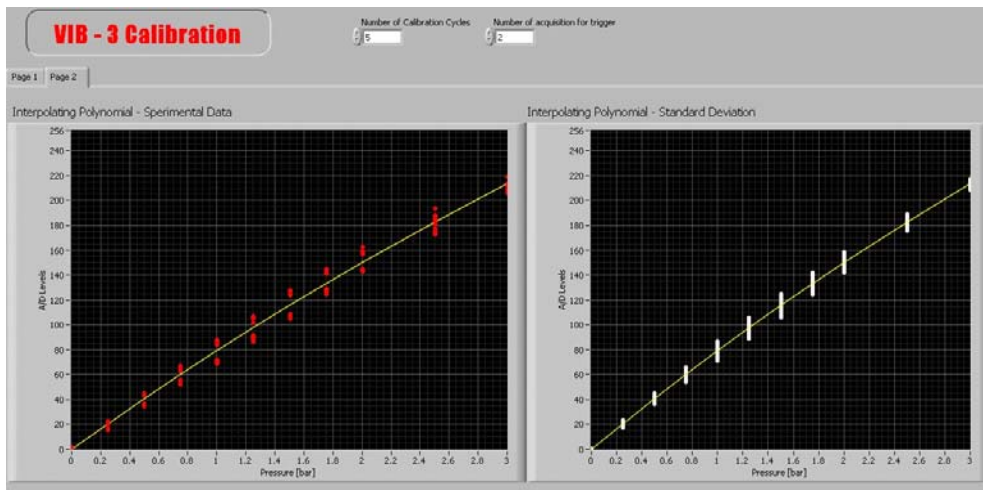
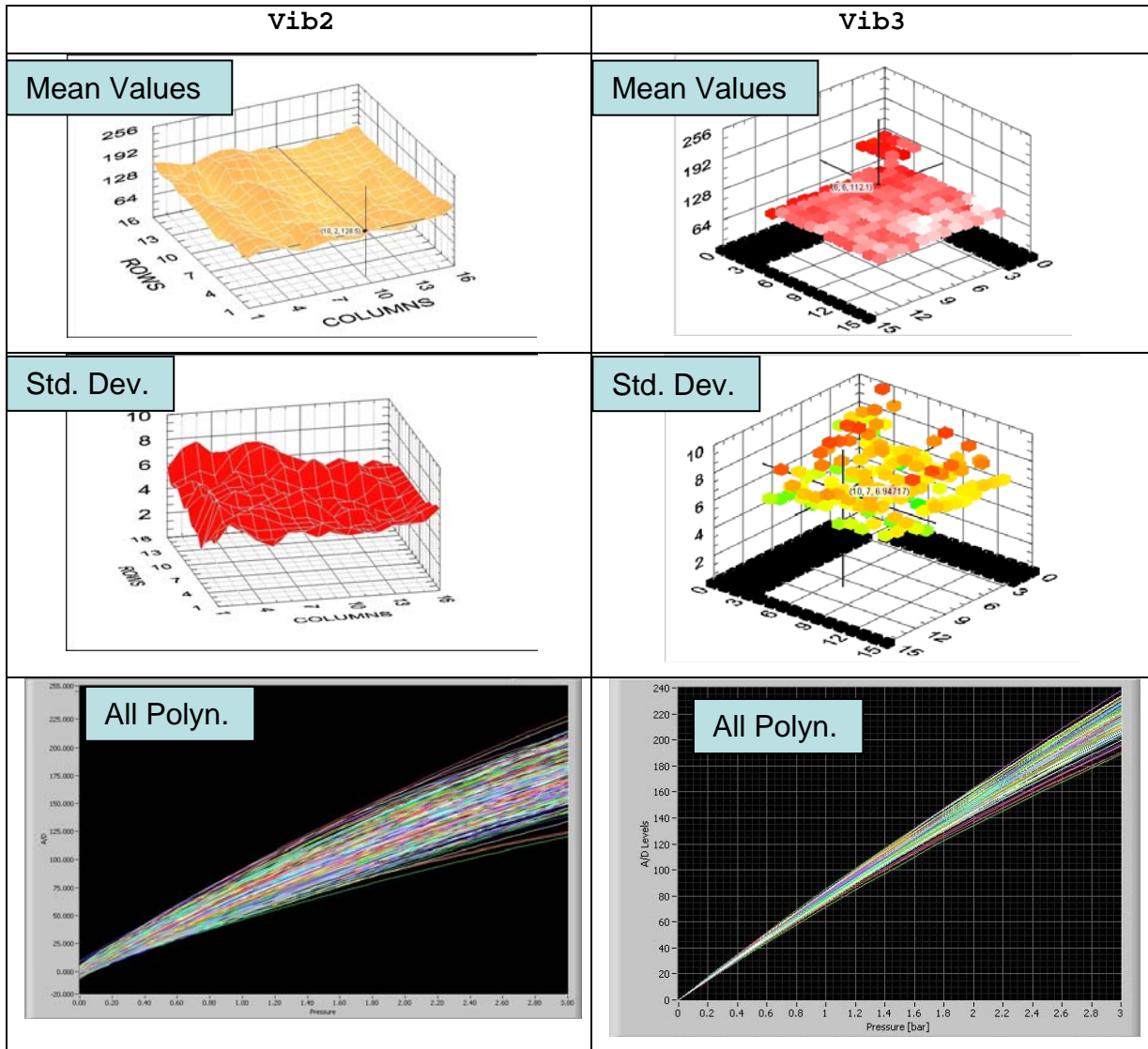

Figure 5 – Uniformity of all sensors, cylindrical calibrator, 256 calibration lines, one single interpolator – 3σ dispersion reported.

Static calibration

Static calibration has put in evidence the following performance.

Sensors across matrices prototypes exhibit a certain dispersion, as documented by the figure below which shows averaged readings and standard deviations across all the sensors. This implies that individual sensor calibration is necessary. This feature is implemented in the software by NOVEL. Sensors exhibit a non-linear calibration curve; experimental data are therefore interpolated by a second order least square polynomial. Non-linearity and hysteresis have been quantified for Vib2 and Vib3 and the finger matrix, which will be extensively used in VIBTOOL project. Experimental data appear dispersed. Overall uncertainty is due to hysteresis and to random dispersion, as it can be seen by the figures below.



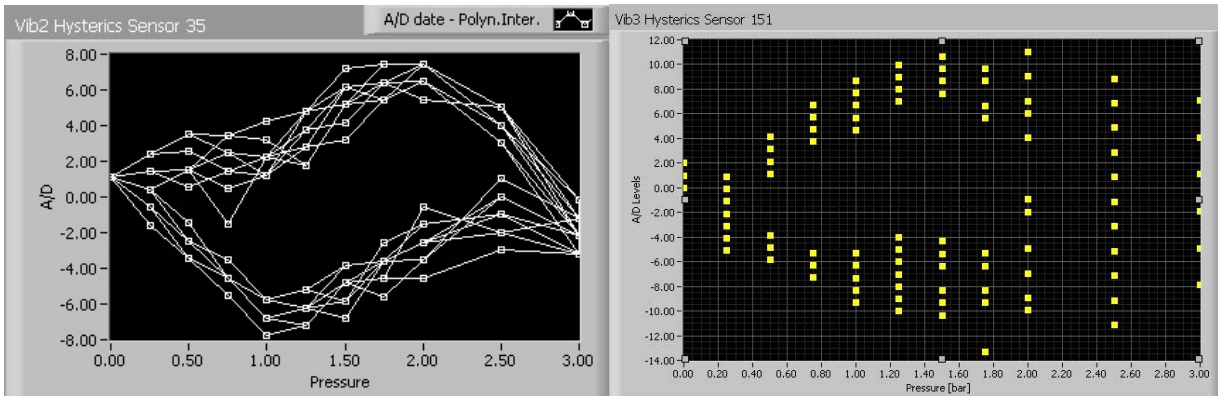

Hysteresis should be a less relevant problem in applications where the peak-peak amplitude of the varying input pressure is relatively small with respect to its mean value, such as during gripping actions. Therefore uncertainty during hand tests will be mostly due to random components.

Comparison between calibration of the sensors in plane and of the sensors on a cylinder of 40 mm diameter shows that sensors wrapped on the cylinder underestimate input pressure, in practice exhibit more stiffness. This effect is of great relevance in this project because sensors will be used wrapped on handles; corrections will be necessary. The difference between Vib2 and Vib3 can be due to the different size of the sensors.

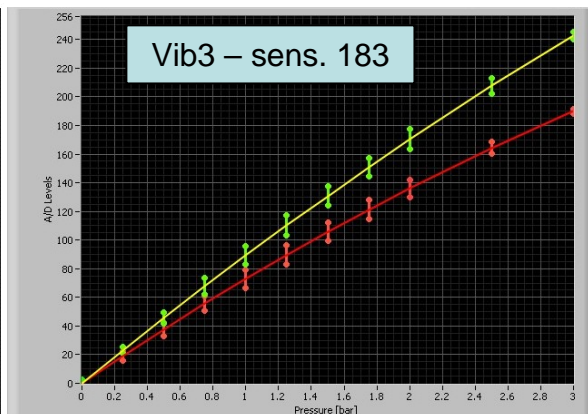
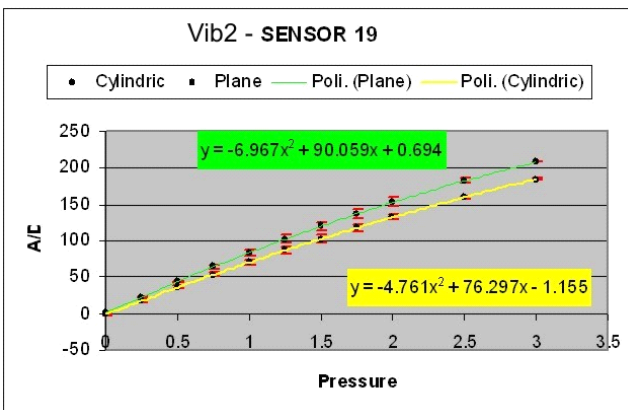

Temperature sensitivity.

The development of a test bench and procedure useful to characterize the effects of temperature on the output signal of the capacitive pressure sensors has been completed (with contribution of subcontractor UNIPG). In order to control temperature and humidity on sensors a climatic chamber has been used, shown on the following figure.



Temperature [°C]	Pressure [bar]	Pressure [bar]	Pressure [bar]
15°C	0.00	0.10	0.20
20°C	0.00	0.10	0.20
25°C	0.00	0.10	0.20
30°C	0.00	0.10	0.20
35°C	0.00	0.10	0.20
40°C	0.00	0.10	0.20

Relative humidity: 50%

The first series of testing condition are illustrated in the following table. The reference load was produced by a large metallic mass with a flat surface put on the sensor matrix; this allows to consider the input pressure constant even if temperature varies. Even if the mass is large, the applied pressure is small because the contact area has to be the whole matrix; maximum pressure was 0.2 bar. Test have been carried out on Vib1, square matrix.



Tests have been carried out in order to estimate the stability of the output of the sensor in the following figures results under loading conditions of 0.10 and 0.20 bar are illustrated.

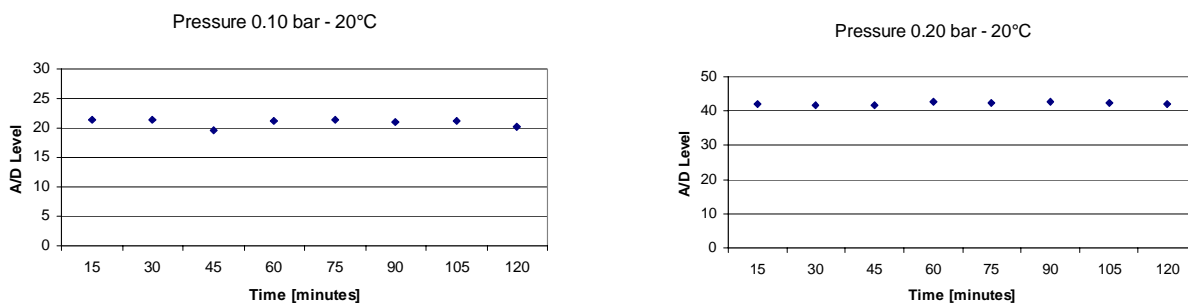

Maximum changes are within the typical sensor uncertainty. Other tests have been carried out in order to estimate the stability of the output of the sensor for temperature variation from 15 °C to 40 °C and in the same loading conditions: 0.10 and 0.20 bar. In the following figures the result obtained are illustrated.

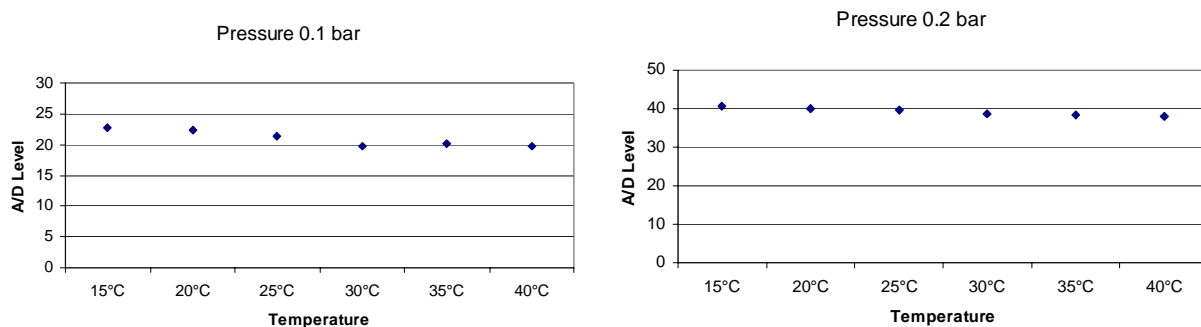

Temperature effects have been quantified in the range 15-40°C. The limit of these tests is the maximum input pressure that is very low, maximum 0.2 bar; higher pressure would require a too large mass. In order to increase the input pressure, a series of tests have been carried out also by a mechanical loading, but no significant results have been obtained due to difficulties in controlling the input load during temperature variations, because of thermal expansion of all mechanical elements.

A second attempt has been the use of a pneumatic loading device, monitored in pressure. This allowed to test up to 2 bar, over a temperature range 0 – 70 °C. Results obtained are illustrated in the following figure.

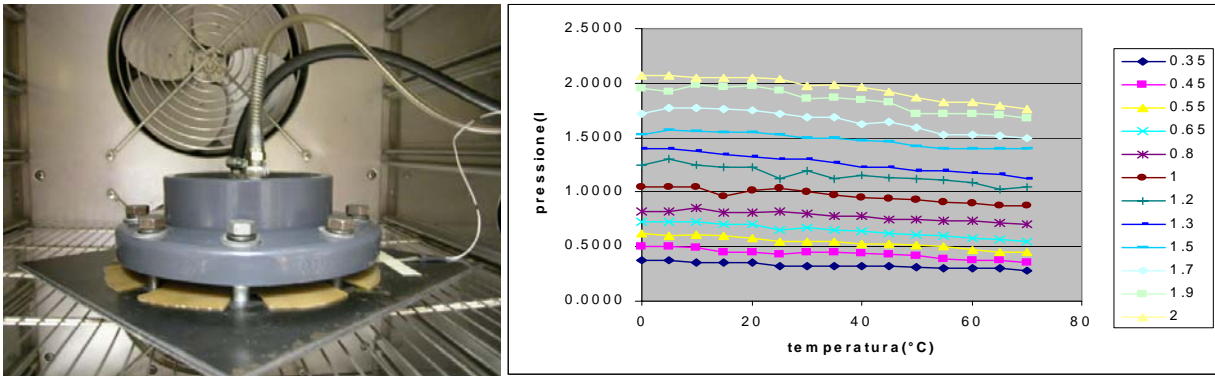

From tests performed the following conclusions can be obtained. If temperature increases then measured pressure decreases. The negative trend is about 0.2 %/°C. For normal variations of temperature during tests ($\pm 10^\circ\text{C}$), this quantity is comparable the typical uncertainty of the sensor.

Cylindrical calibrator.

It has been designed and realised a new cylindrical calibrator for on-field calibration of capacitive sensor matrices. The goal is to have a device that can be wrapped around the handle where the matrix is used. The new calibrator should allow an easier use and has been designed in order to be clamped on handles. The CAD model of the calibrator is illustrated on the following figures.

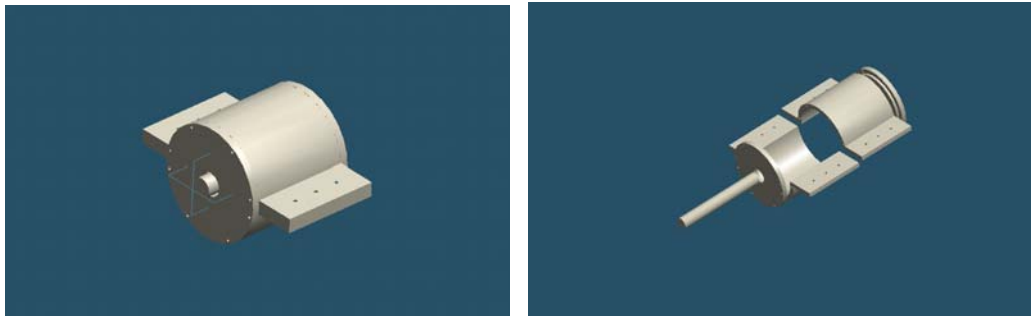

The calibrator has been realized in steel, in order to ensure a rigid structure, and is illustrated in the following figure with the matrix inside. New lighter version should be realized using plastic materials, to reduce weight.



Dynamic calibration.

At UNIVPM, it has been carried out on a limited number of sensor of Vib2 (1 sensor (137) at the centre of the matrix) and of Vib3 (3 sensors, n.30, 67 and 167). Three different approaches have been used to determine sensor Frequency Response Function FRF: impulsive excitation, sinusoidal excitation, sine sweep.

Impulsive excitation has been applied by an instrumented impact hammer, with the matrix placed on a stiff, heavy and flat surface. The impulse is applied on a rigid disk put on the matrix (3 cm diameter, area 7 cm²), so to cover more than one sensor; the sensor under test is at the centre of the disk. Signal from the sensor is sampled by using an external clock at 5 kHz. The same clock signal drives the A/D converter of the data acquisition system which measures input force from the instrumented hammer (see scheme of the test bench).

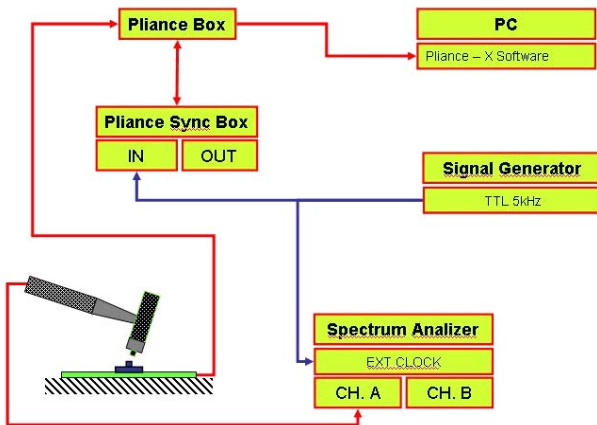

Averaged FRFs have been computed over 10 inputs. Data from Vib2 sensor 137 are grouped for different peak force, so to investigate into non-linear effects for Vib2 (peak force falls in the ranges 50-100 N, 100-150 N, 150-200 N). All FRFs from Vib2 and Vib3 show a typical damped response, with a typical bandwidth of 450 Hz (measured at half the response at 0 Hz, that means -3 db).

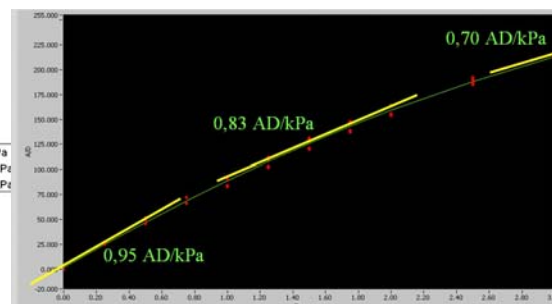
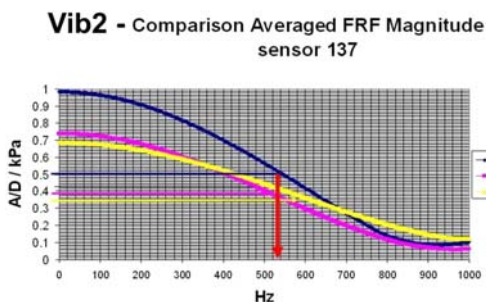

FRF shape and bandwidth do not vary significantly with peak load, but static sensitivity at 0 Hz is decreased when peak load increases; this fully agrees with the reduction in static sensitivity that can be observed in the static calibration due to non-linearity. The FRF is the same considering 3 different sensors on Vib3. To better investigate into FRF of a non-linear system, being the sensors non-linear, it is important also to apply sinusoidal loads. The load has been applied by an electro-dynamic shaker feedback controlled in force, via a load cell and a digital controller. A spherical joint has been inserted to provide a uniform loading of the sensor under test.

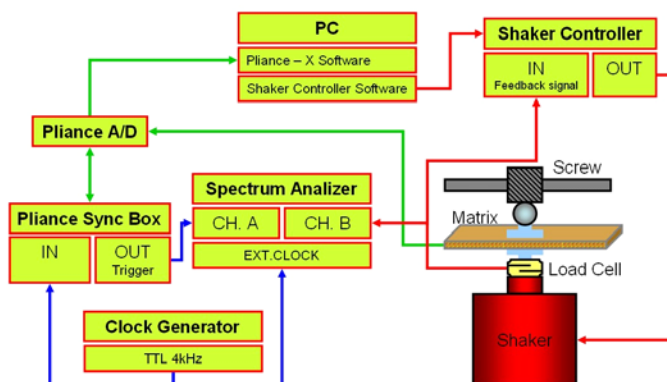

The contact disk between the spherical joint and the matrix sensor has a diameter of 3 cm. At the date of the report, only data available is a sine sweep excitation from 10 to 300Hz applied on sensor 104. The tests have been performed with a preload of 50N (pressure of 7 N/cm²) and a peak-peak amplitude of 50 N (pressure 7 N/cm²). Such values are in the range of typical contact pressure during hand gripping of tools. Results are reported in the following figure and are in line with the dynamic tests made by impulse excitation, in the band where signal to noise ratio is sufficient.

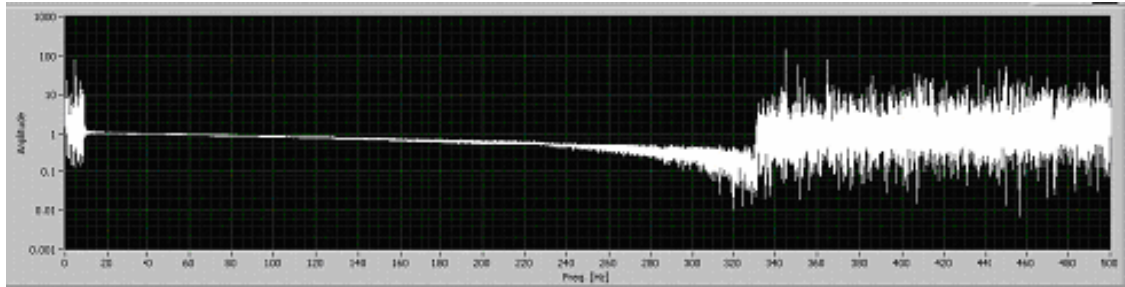

WP 5: Metrological analysis of instrumented glove.

Workpackage Manager: INRS; Partners involved: INRS.

Objectives

Aim of WP5 was to analyse the metrological performance of the glove sensor.

Scientific and technical description of WP5.

Preliminary studies, carried out by INRS before the VIBTOOL project, led to the design of a pressure glove. This prototype of glove was made of five strips of flexible sensors in the shape of fingers and was manufactured by NOVEL (see figure 1). It was used within the frame of the VIBTOOL project to assess its ability to measure coupling forces. The shape of the sensor strips was not adapted to be used with a current textile glove: The strips need to slide along the fingers during bending movements and this was made impossible by a textile glove. That is the reason why a specific glove was produced with the finger extremity and the palm area kept open (see figure 1).

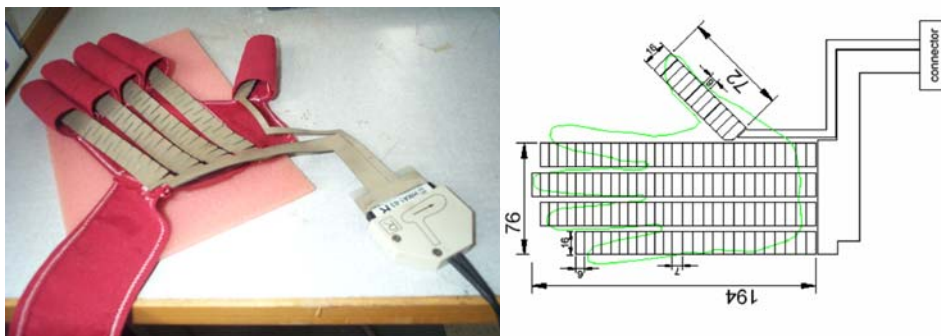

Figure 1: initial prototype of pressure glove (125 individual sensors, max freq : 78 Hz).

A critical issue is the knowledge of sensor position in space; it means its spatial location and its orientation. The locations of the individual sensors around the handle were required to compute the coupling forces, the direction of every contact force being related to the sensor location by simple trigonometric rules. They were not easy to determine because the strips tend to bend and twist when holding the handle. For all the tests performed in the laboratory and for a given subject, it was assumed that the relative position of the sensors around the handle remained unchanged, whenever the handle was released and grip again. The location of each individual sensor was then assessed by an imprinting technique: a dummy glove, made of rubber strips (size and shape identical to the sensor glove) was imprinted with ink and the handle was wrapped with a sheet of paper. The prints resulting from the grip were then used to find the location of the sensors. Two methods of identification were tested. With the first method, the position of some remarkable sensors was determined and all the other positions were deduced from linear interpolations. The sensor strips were assumed to remain in a straight line when gripping the handle (see figure 2).

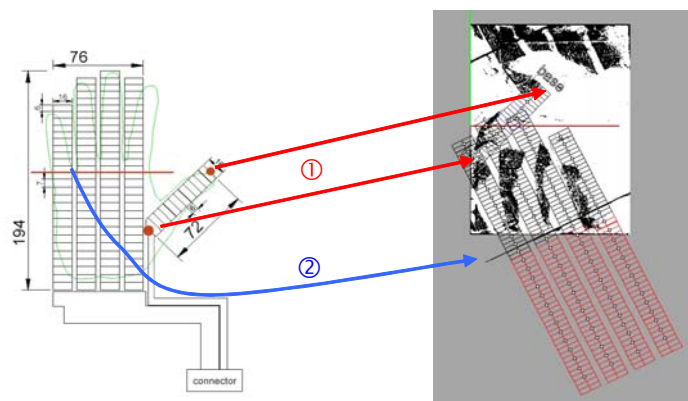

Figure 2: simplified method to locate the sensors around the handle (1-locate the thumb strip extremities; 2-locate the finger base line and operate a rotation of the strips).

With the second method, the sensors were localized individually or by subsets (see figure 3). This method was obviously more accurate but required a lot of time. In both procedures, the information of interest was the angular position of the sensors, i.e. the vertical coordinate with respect to figure 2 and figure 3.

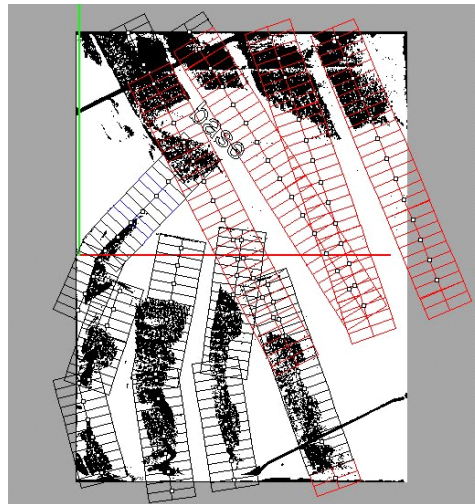

Figure 3: second method to locate the sensors. Sensors or subset of sensors are located individually.

These two procedures were not judged as sufficiently reliable to ensure a good precision of the coupling force assessment. A more accurate and reliable procedure was then developed. The handle was marked with longitudinal grid lines regularly spaced in 15 degrees intervals. A thin rod was placed along one of the grid lines to induce a local thickness over the covered area. The rod was moveable along the handle circumference. Exploiting the possibility of displaying the constrained sensors by means of the NOVEL software PLIANCE ONLINE, the subject was asked to hold the handle, taking care to exert a higher effort in correspondence to the rod. The sensors displayed on screen as highlighted could be assigned to the angular position marked by the rod. This step was repeated 24 times along the total circumference. Then this angle capturing procedure was made more convenient with the design and the production of a specific handle (see figure 4). The handle is composed of 24 longitudinal blades spaced regularly (15°). There is a lug on the handle axle, which can move the selected blade so that it juts out the handle surface. As previously, this method is based on the assumption that the same posture can be repeated, whenever the operator releases and grips the handle again.

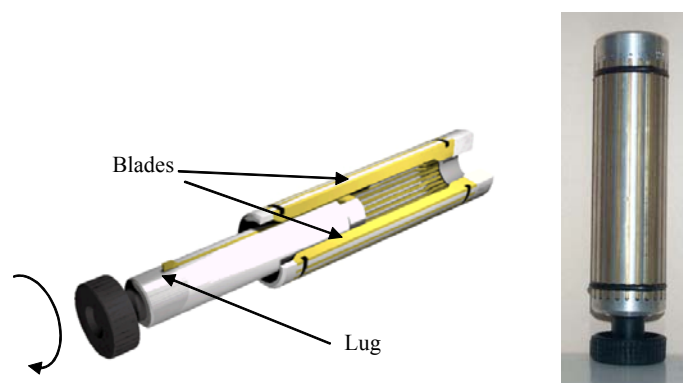

Figure 4: specific handle devoted to the angle capturing procedure (schematic diagram on the left; overview on the right)

An instrumented handle was used to measure push and gripping forces directly. This handle was equipped with strain gages (to measure the gripping force along a given axis, perpendicular to the support axis) and mounted on a 6-component load cell. At the same time, the glove prototype was used to measure the pressure mapping at the interface between the hand and the instrumented handle. A spectrum analyzer was used to

acquire the direct push and gripping forces and the trigger output channel from the NOVEL acquisition system (see figure 5). During the tests, the direct forces were monitored by means of a digital oscilloscope. The direct force measurements were then post-synchronized with the pressure measurements.

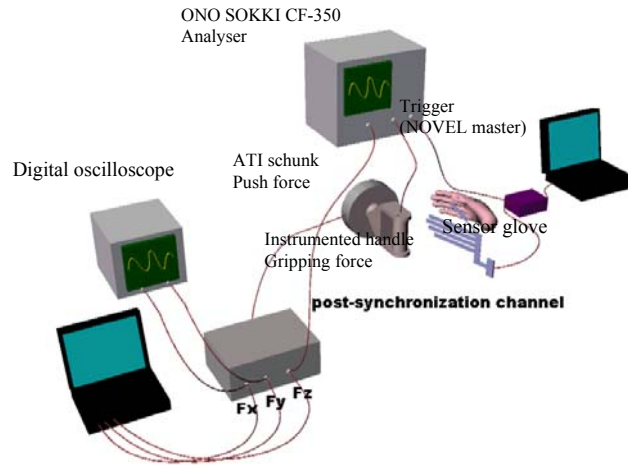

Figure 5: test apparatus for the measurement of coupling forces and the validation of the sensor glove.

A series of 9 tests was carried out to compare the coupling forces measured directly by the sensors with the forces integrated from the pressure data, according to the definition given in equation (1) and (2). The first 3 tests were pure gripping tests with increasing levels. The 3 following tests were pure push tests with increasing levels. Then, the last 3 tests were combined load cases (push and gripping simultaneously). Figure 6 shows an example of one pure gripping test and one pure push test.

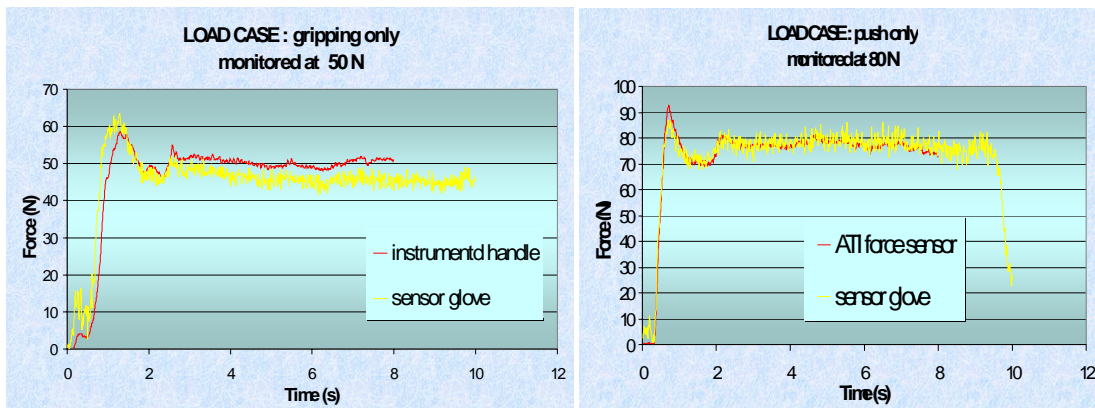

Figure 6: comparison of coupling forces measured directly and computed from pressure mapping. (gripping on the left; push on the right).

The RMS values of the coupling forces were computed for every tests performed and presented in table 1:

Load case	Gripping			Push		
	Glove sensor (N)	Inst. Handle (N)	Error (%)	Glove sensor (N)	ATI sensor (N)	Error (%)
1	30	26	13,3	-	-	-
2	45	50	10	-	-	-
3	88	93	5,3			
4	-	-	-	39	37	5,1
5	-	-	-	78	78	≈ 0
6	-	-	-	118	108	8,4
7	56	53	6	12	19	36
8	55	55	≈0	28	32	12,5
9	29	29	≈ 0	35	40	12,5

Table 1: comparison of the mean values of coupling forces measured and computed from pressure mapping.

The results show good correlation between measured and computed forces, i.e. less than 14% of differences. All these tests were realized by a female subject, because the size of the glove was not adapted to male hand dimensions. In particular, the strips were not wide enough to cover the whole palm when used by a man. For that reason, new dimensions needed to be specified to adapt the sensor glove to typical male hand sizes. This has led to the design of a new prototype. In figure 7, the final version of the sensor glove prototype, realised by NOVEL, is reported.

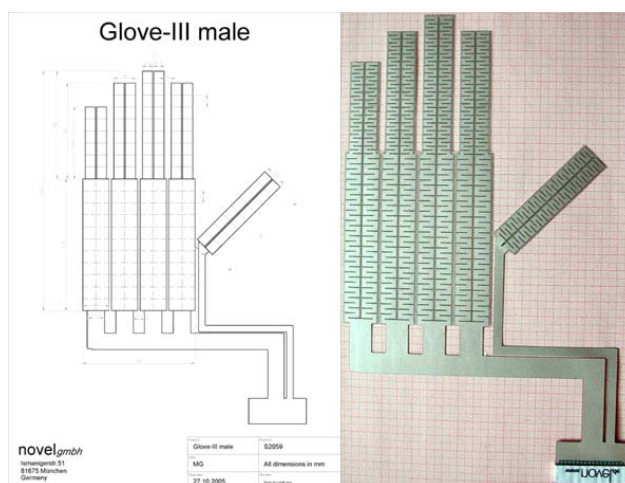

Figure 7. **D2** Glove sensor: GloveIII.

The laboratory tests showed that it was possible to measure the coupling forces with the help of a pressure glove, it turned out not to be realistic to plan field experiments with such a testing device. The main reason was the angle capturing procedure, which was still too complex to be implemented in the field, at this stage of the development. No feasible solution could be expected in a short term. In a longer term, measuring both the angle positions of the finger joints, with the help of a cyber glove for instance, and the pressure mapping with the pressure glove, could solve this problem. Unfortunately, to our knowledge, the cyber gloves available in the market are not sufficiently reliable to ensure accurate measurements of the joint angles, especially at the CarpoMetaCarpal joint. In any case, further developments would have been necessary to model the deformation of the soft human tissues in contact with the handle, in order to compute the angles of the individual sensors. So, the decision was made among all VIBTOOL participants to concentrate on the FINGERMAT sensor matrix developed in the project by UNIVPM and NOVEL.

WP 6: Test of sensors in laboratory conditions.

Workpackage Manager: CNR-IMAMOTER; Partners involved: CNR-IMAMOTER, BREAKERS, UNIVPM, INRS and NOVEL.

Objectives

Aim of WP6 is to carry out contact pressure and grip force measurements on hand-held tools/machines in laboratory test conditions.

Scientific and technical description of WP6.

Within WP6, and in parallel to WP7, UNIVPM participated and contributed, as instrument developer, to all test sessions on power tools both in laboratory conditions with partners Lifton-Breakers; HVBG/BGIA and CNR-IMAMOTER. All the activities have been carried out as planned; in fact:

- personnel from UNIVPM participated directly to a 1 week test session at BREAKERS laboratories, together with Lifton-Breakers personnel;
- the analysis of laboratory testing of breakers was conducted by personnel of UNIVPM;
- BREAKERS provided a hydraulic breaker to HVBG/BGIA and this was tested by personnel of HVBG/BGIA and UNIVPM in WP6 and WP7.

Therefore the difficulties were successfully managed within the VIBTOOL consortium, with an internal redistribution of man-power and resources. The following types of tools were tested in laboratory conditions in WP6.

- Impact drills (at UNIVPM in Ancona)
- Chain saws and brush cleaners (at IMAMOTER in Turin)
- Hydraulic breakers (at BREAKERS in Aalborg)
- Pneumatic breakers (at INRS in Nancy).

UNIVPM and INRS performed an analysis of the measurement procedure and developed hw and sw suited to perform the tests.

Data acquisition HW and post-processing SW for laboratory and field tests (UNIVPM and INRS).

For the purpose of performing the tests, UNIVPM has developed a system that allows parallel and synchronized acquisition of accelerations, forces and pressure distributions from 2 Pliance-X Systems and a post-processing software to compute RMS levels of Wh weighted accelerations according to ISO 8041. This system has been used for tests during WP6 and WP7 also by other partners (HVBG/BGIA, BREAKERS and IMAMOTER), supported by personnel of UNIVPM.

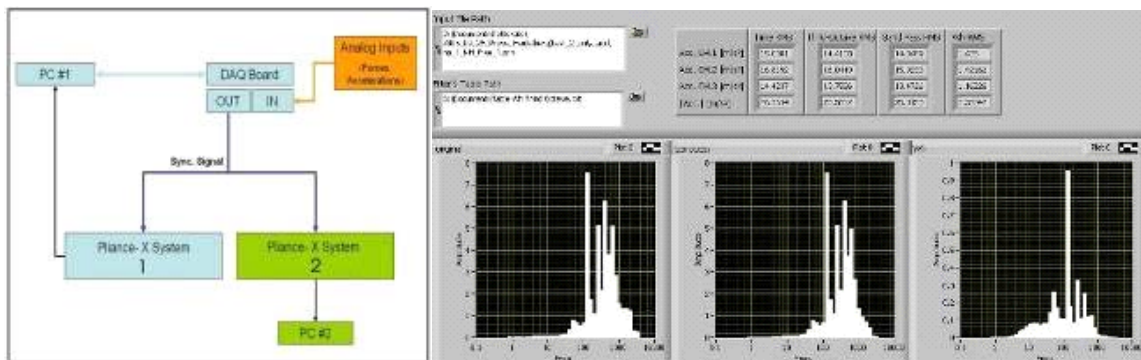

The software to calculate grip and push force from pressure distribution provided by the Pliance – X system developed during the 2nd year of the project was upgraded and improved in order to implement all push and grip force definitions proposed by partners involved in WP9 – Standardization Issues.

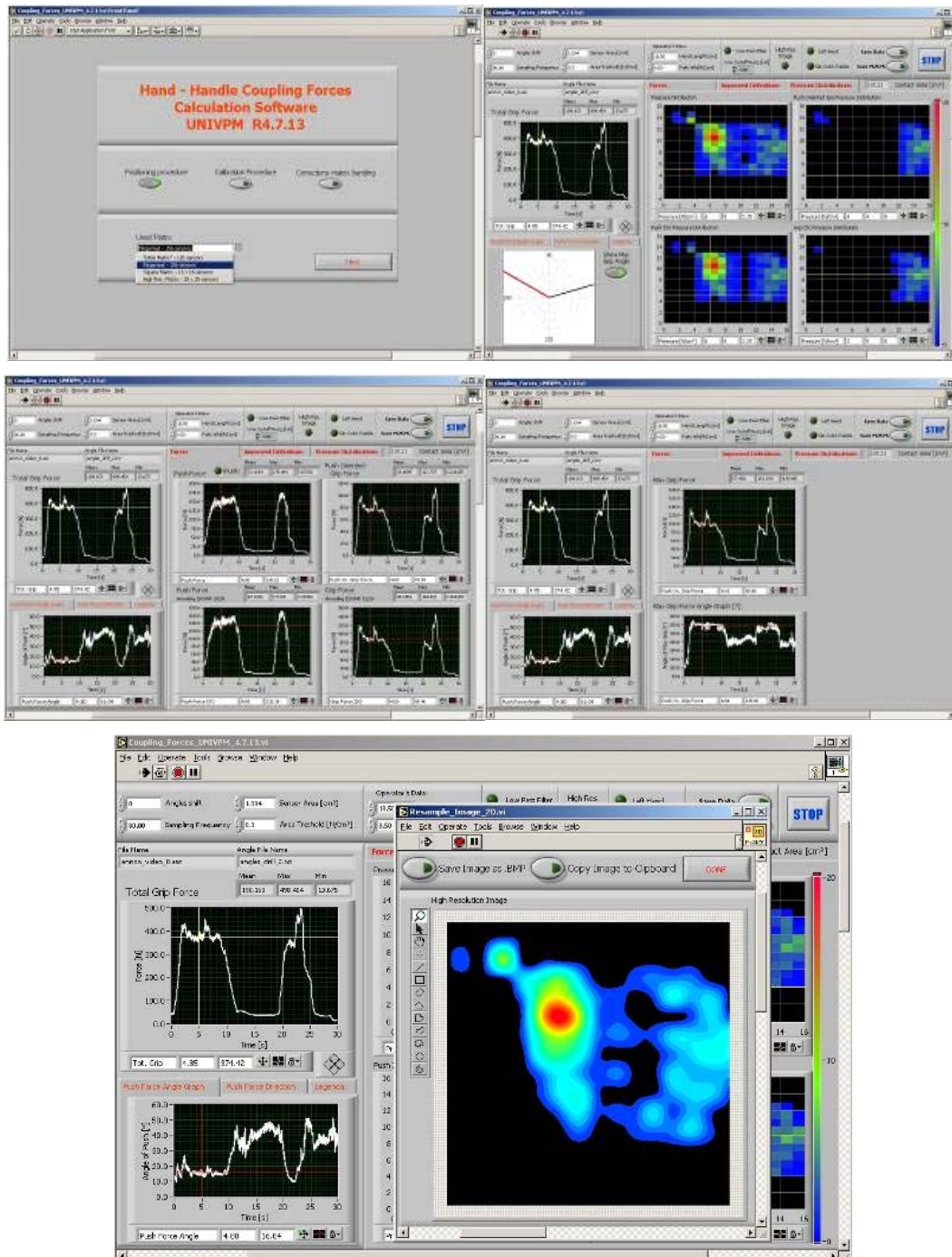

A self-executable program embedding all the procedure of pressure integration was implemented also by INRS. The intention was to design an integrated routine that helped the experimenters to quickly obtain the results of force measurements in the laboratory and in the field.

This software was developed from the specifications provided by the partners involved in Field-tests. Configuration files are needed as input. These files give a description of the sensors (size, number, numbering and their orientation relative to the handle). All these data are listed in ASCII files. So, the software may be used for all types of NOVEL sensors, matrices and gloves. Filtering settings are built-in (high-pass and low-pass). The following values are computed, displayed and written in ASCII files :

- push force, push direction
- grip force calculated for an arbitrary direction of observation (the angle of observation may be changed and the corresponding grip force is displayed instantaneously).
- maximum gripping forces and the corresponding angle of observation.
- All the previous values are displayed as time histories and Min, Max and RMS values.
- The instant pressure mapping is displayed in 3D over the handle geometry.
- All the coupling forces computed by the program may be displayed in addition with direct force measurements, in order to make comparisons.

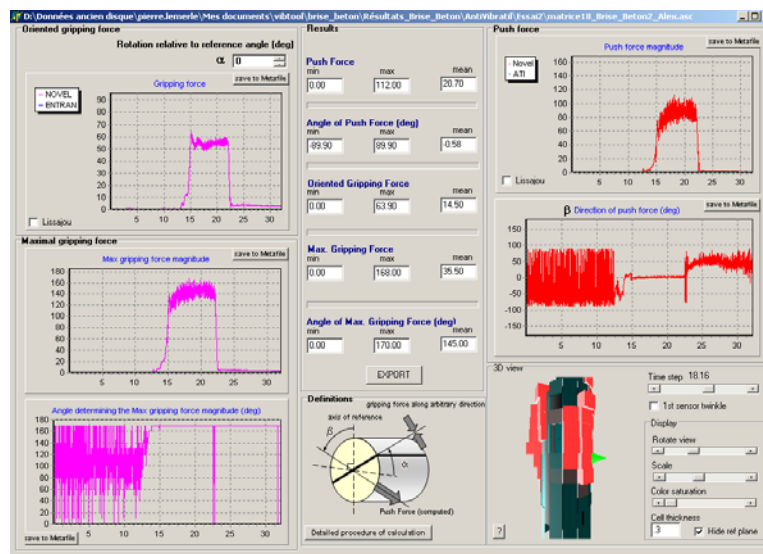
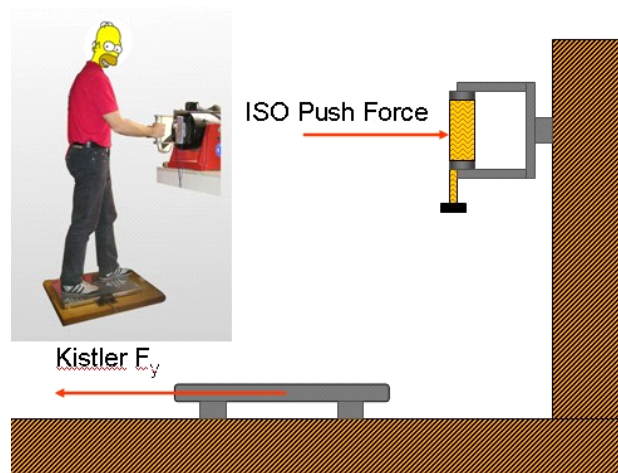

Figure : Screen capture of the post-processing software developed by INRS for field-measurements.

Determination of expanded uncertainty on the measure of the Push Force with the NOVEL Fingermat Sensor (at UNIVPM)

It was performed by direct comparison of the Push Force calculated by the matrix according to ISO/NP 15230 with a Instrumented Kistler Platform 9286AA. The test setup is shown in the next figure.



Different tests were performed:

- 9 Different Subjects
- 10 tests at not controlled push force, different grip (High Grip, Low Grip)

- 10 tests at not controlled grip force, different push (around 50, 100, 150N)
- 30 seconds of acquisition for each test

Each time history was in the following way:

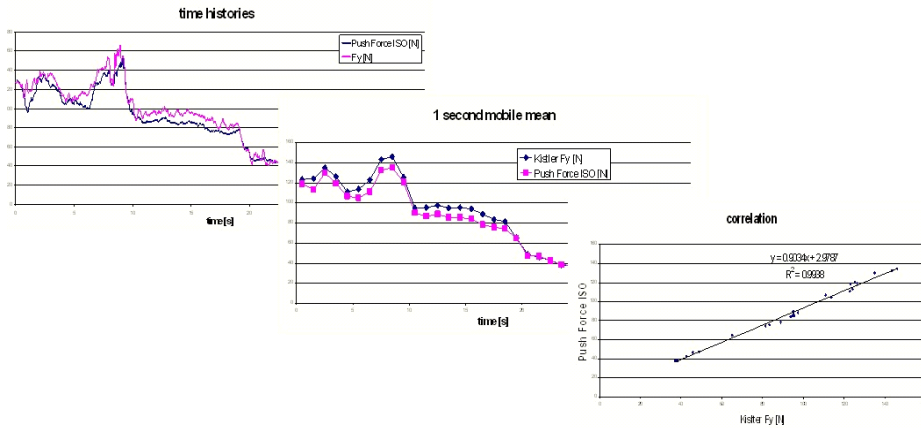

Results show that the Push Force computed with the matrix is systematically lower than the reference Push force measured by the platform. Statistical tests (A.N.O.V.A., χ^2 .etc...) shows that the correct estimation of Push Force depends mainly on:

- Amount of partially loaded sensor (that is related to the contact hand-handle area, that depends on the Grip Force level)
- Handle diameter (bending of the matrix)
- Shear components of forces (which are not measurable by the pressure sensors)

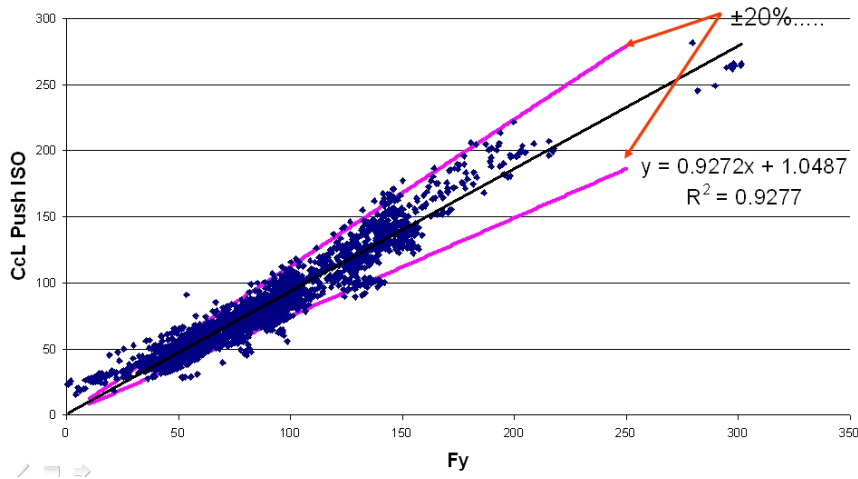

Analysis of data shows that removing systematic factors, expanded uncertainty can be estimated as a 20% of the reading, with a confidence level of 80%.

Development of a measuring procedure and performance analysis for Grip force measurement

An instrumented handle was designed and manufactured by INRS (figure 10), in order to have a reference measurement of Grip force. It was composed of two half cylinders linked by two ball bearing translational joints, in order to lower the friction forces. Two unidirectional force sensors were inserted in the symmetry plane to measure the action forces from one half-handle to the other. The support was mounted on a 6-component load cell. The length of use is 235 mm and the diameter is 40 mm.

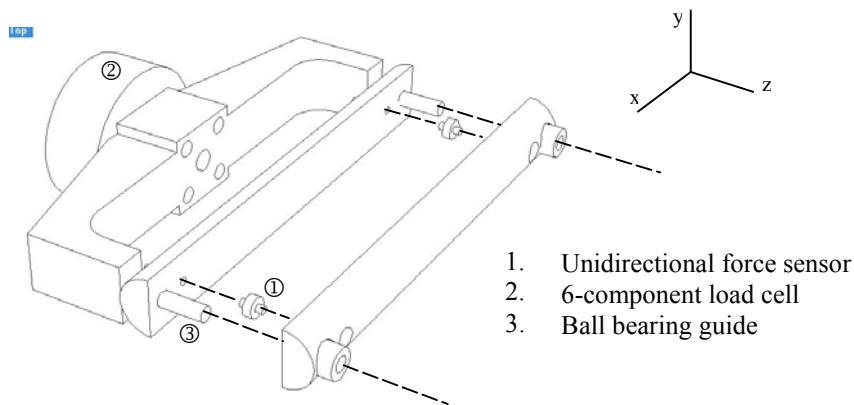

Figure 10: exploded view of the instrumented handle

Before using the handle as a reference system, a lot of care had to be put into the verification of its accuracy. First, the uncertainty of the 6-component load cell was checked by simple static load measurements with weights. Then, the precision allowed by the assembly and the guiding was checked in details. The main concern was to verify that friction forces would not affect the measurements of the contact forces between the two half-handles. Push forces were exerted by the operator on the mobile half-handle. In that way, the force measured by the unidirectional sensors (summation of the two measured forces) had to be equal to the force measured by the load cell (Z component). Different levels were tested (50 N, 75 N, 100 N, 150 N) and the push forces were applied at three different locations along the X axis: in the middle, at the top and at the bottom of the handle. Obviously, the last two configurations were the most severe because they could cause a rotation of the half-handle along Y axis and then induce friction in the guiding. Figure 11 shows the results obtained with a push force of about 100 N (all the results are presented in Annex 2), the application point being located in the middle, at the top and the bottom of the handle. As can be observed, a very good correlation was obtained between the load cell measurements and the unidirectional sensor measurements, regardless of the application point.

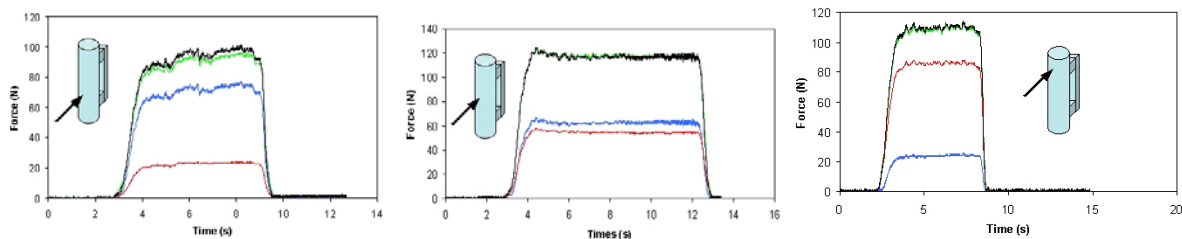

Figure 11: validation of the instrumented handle; comparison between the push force measured by the 6-component load cell (green) and the forces measured by the unidirectional sensors (blue: bottom sensor, red: top sensor, black: top+bottom). The results of the validation tests were judged satisfactory to consider the instrumented handle as a reference testing system. The FINGERMAT matrix was tested in the laboratory to verify how accurate could be the contact pressure measured to provide accurate measurement of coupling forces. Tests highlighted several factors influencing the accuracy of the results:

- The range of calibration: the resolution of the acquisition system is proportional to the range of calibration, at the 8 bit A/D converter stage. In practice, the range [0-3 bar], with a resolution of 0.125 bar, was chosen for the tests and no overload was ever observed, even for high grip and push.
- The curvature: the effect of curvature was studied by partners of the UNIVPM in WP1, with square matrices. It was found that a pre-constraint was induced when bending the sensors and measurements were affected consequently. The tests performed with the FINGERMAT confirmed this effect. The FINGERMAT matrix was wrapped around several cylindrical shapes with different diameters (40 mm, 80 mm, 160 mm and : plane surface, see figure 12).

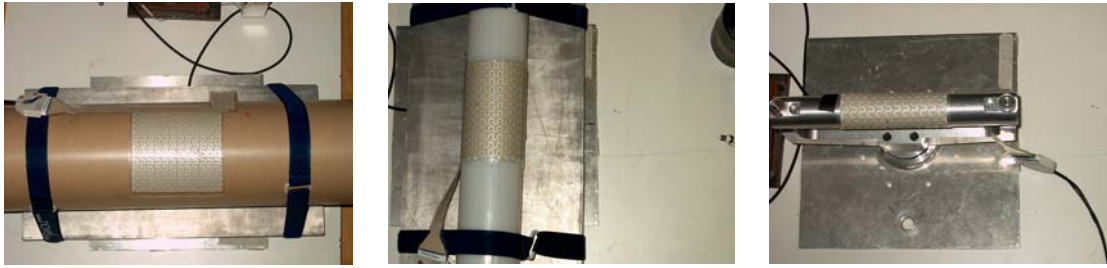

Figure 12: FINGERMAT matrix wrapped around 3 cylinder of different diameter (160 mm on the left; 80 mm in the middle; the 40 mm diameter instrumented handle on the right)

The cylinder was fixed to a rigid plate mounted on a 6-component load cell. The instrumented handle was used as a 40 mm diameter cylinder.

4 subjects (3 male, 1 female) were asked to exert a push force and the force measured by the load cell was compared to the force computed from the pressure maps. Different levels of forces were tested.

- **Remark:** the angle capturing procedure is simple because of the geometry of the matrix and the shape of the handle. Only the position of one individual cell around the handle is needed. The locations of all the other sensors are deduced automatically: the sensors of same rows have the same angular position. The sensors whose positions differ in n rows have angular positions distant from $n \times 10.5 \times 360 / (2\pi d)$, 10.5 mm being the dimension of one individual sensor and the angle value being expressed in degrees.

Figure 13 shows the result obtained with one subject with the different cylinders and the flat surface. All the results are presented in Annex 3.

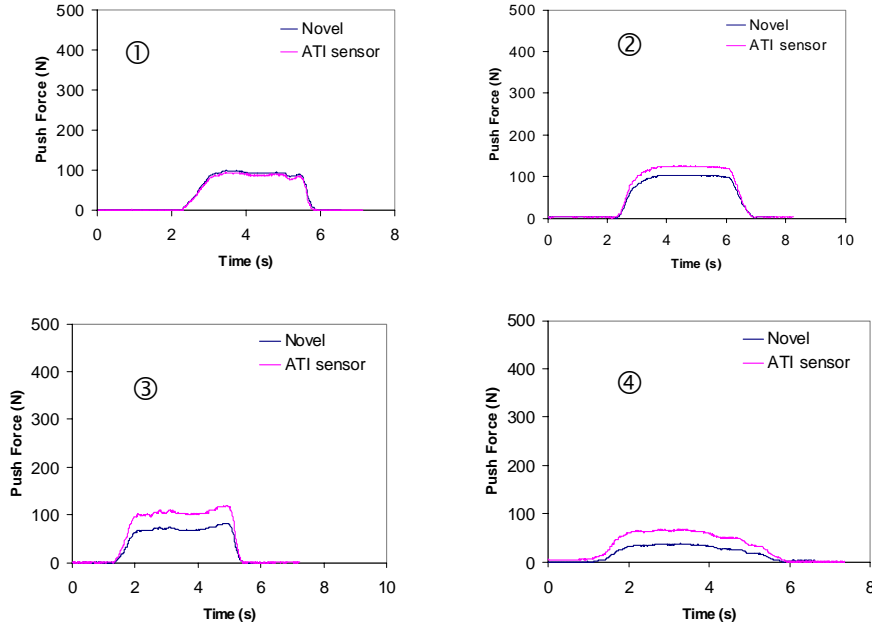

Figure 13: push tests realized with the same operator on a flat surface (1), 160 mm diameter cylinder (2), 80 mm diameter cylinder (3), 40 mm diameter handle (4). (direct measurement : blue; pressure integration : pink)

Good correlation between direct force measurements and integration results may be noted for the flat surface. The correlation is worse for smaller diameters.

The pressure integration leads to an underestimation of the push force. The difference between the direct measurements and the pressure integrations was expressed in terms of percentages in Figure 14 for all the

tests performed. It is noticeable that the lower the diameter the higher the difference. With the flat surface an excellent correlation was obtained (less than 1%).

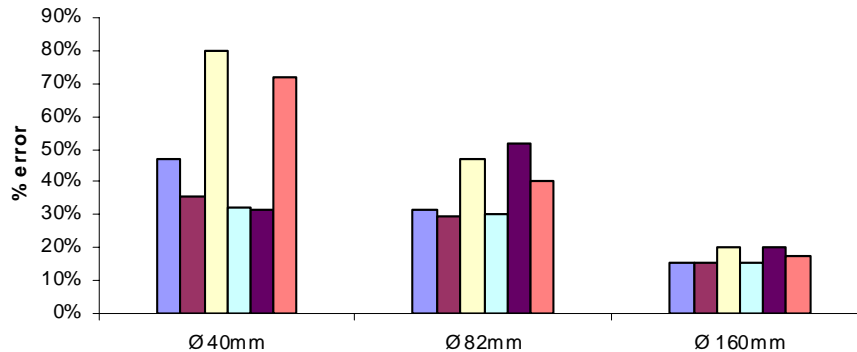

Figure 14: effect of curvature on the force measurement. Difference between the mean push force measured with the load cell and the mean push force computed from pressure integration.

Bending the FINGERMAT matrix causes a pre-constraint because of the internal mechanical couplings between the individual sensors. The PLIANCE software embeds a compensating procedure, which consists of canceling the offset at the A/D converter stage (option “zero settings” in PLIANCE software). Because the physics of the capacitive sensors is non linear, this offset compensation procedure was not adapted. A new offset compensation procedure was tested: the offset caused by the wrapping and then the bending was compensated after the A/D conversion. In practice, the measurements were carried out without any correction. Each test began with the matrix unloaded. The initial frame (first instant pressure map) was stored in memory. Then during the post-processing phase, it was recalled and subtracted to the instant frames, frame by frame, individual sensor by individual sensor.

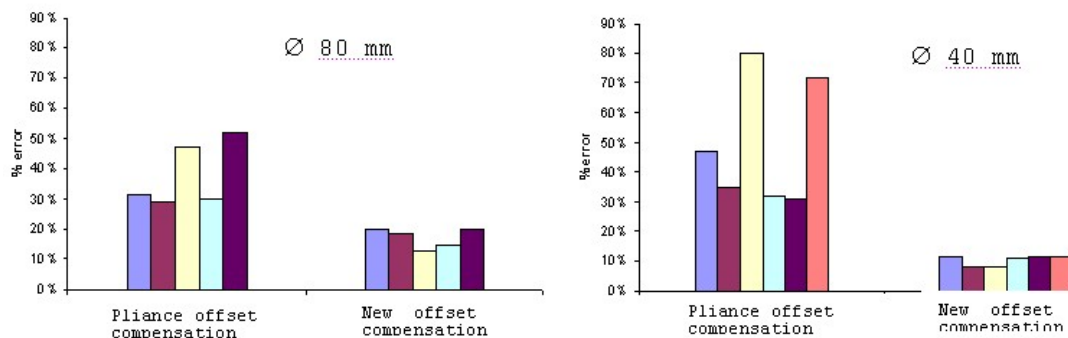

Figure 15: effect of the offset compensation procedure. (80 mm diameter cylinder on the left; 40 mm diameter cylinder on the right). Difference between the mean push force measured with the load cell and the mean push force computed from pressure integration

Figure 15 shows clearly the effect of the offset compensation. The difference decreased considerably when the new offset compensation was used.

Then series of push and gripping tests were realized with the instrumented handle, taking into account the experience gained from these preliminary experiments. 3 subjects were asked to exert a pure push, then a pure grip and finally a combined force in the same run. The tests were repeated for each subject. Figure 16 shows examples of comparisons between computed coupling forces and direct measurements for 2 subjects. Good correlations were obtained for two subjects. The test realized with the third subject (see test n°2-subject n°2 in figure 16) led to poorer correlations.

The friction could be the reason of such discrepancies. This was investigated with specific experiments. The subjects used surgical gloves covered with a gel whose formulation is adapted for electrotherapy

ultrasonic transmission. Then a thin film was automatically formed over the hand surface when gripping the handle and the friction was considerably lowered. The same testing procedure was then applied to compare direct force measurements with pressure integrations.

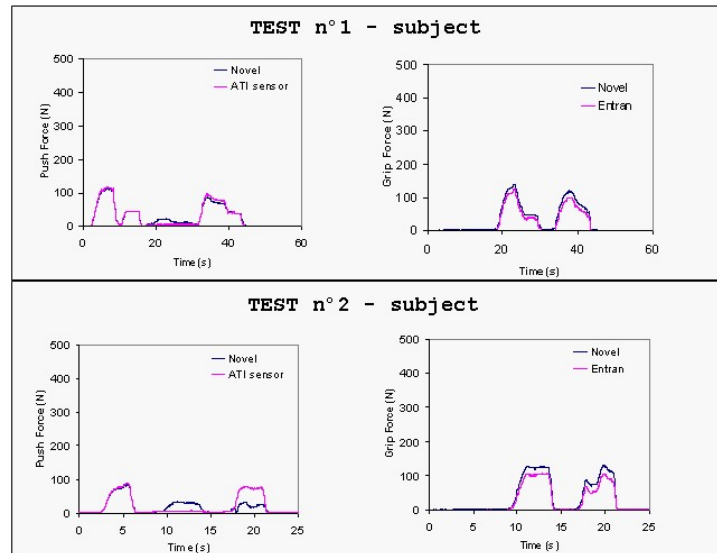

Figure 16: comparison between direct measurements of coupling forces and results of pressure integrations.

Figure 17 shows a sample of the results obtained. The test was performed by the subject numbered 2 in the previous test session (see figure 16).

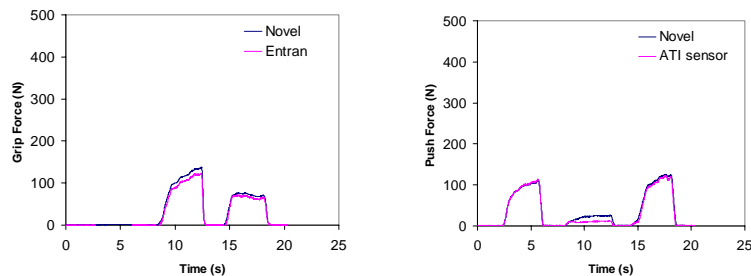

Figure 17: comparison between direct measurements of coupling forces and results of pressure integrations, with low friction control.

Regression analysis showed good correlations for push forces (less than 10% of linear distortion) and gripping forces (less than 20% of linear distortion). These experiments demonstrated the effect of friction which cannot be neglected at low levels. At higher levels, the assumption made in the definition of coupling forces (see equations (1) and (2)) becomes more relevant.

Laboratory tests on impact drills according to ISO 8662-6 (at UNIVPM).

With the aim to estimate the application of the matrix on vibration tools, like previewed in the WP6, a series of tests in laboratory condition is carried out. These tests are made in according to standard ISO 8662-6. This standard refers to the measure of the vibrations on the handle of portable tools with specific reference to the impact drills. The portable tool used is a impact drill BOSCH model GSB 18-2 (fig. 1)



Figure 1. Impact driller mod. BOSH GS 18-2

As evident from the figure the start switch has been blocked wrapping tape on the handle of the tool. This allows us to avoid that the operator during the test applies an additional and variable force in order to maintain the switch in position of on. In order to estimate the force of push and the vibration on the handle of the impact drill (referring to norm 8662-6) it is used respectively :

- Dinamometric plate of Kistler (fig.2.1: in laboratory ; fig. 2.2: in standard 8662-6)



Figura 2.1



Figura 2.2

- Accelerometer ICP[®] and relative electronics of conditionig (fig 3.1: in laboratory fig. 3.2: in standard 8662-6)

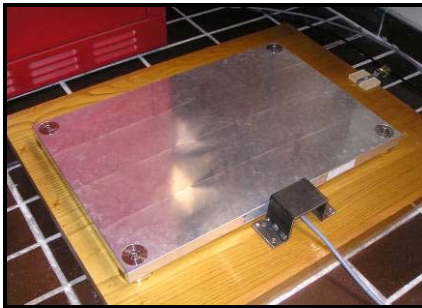

Figura 3.1

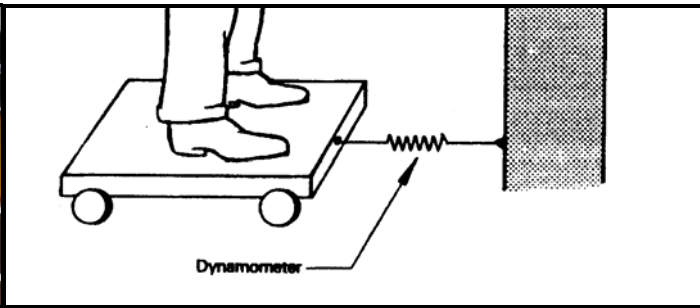

Figura 3.2

To estimate the grip force is used :

- Matrix of capacitive sensors (NOVEL) wrapped accurately on the handle of the impact drill (fig 4) and relative electronics.

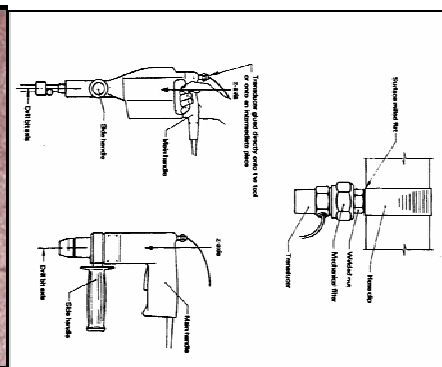

Figura 4. The fingermat wrapped on the driller handle.

Referring to standard ISO 8662-6 these measure instruments (except the matrix that is not cited in the standard) are linked in the following configuration (fig. 5.1: in laboratory fig. 5.2: in standard 8662-6), to the aim to assure to the operator the maintenance of the prefixed postura during the test and so have the test itself more repeatable.



Figura 5.1



Figura 5.2

The measurements are carried out respecting the following measure conditions:

- 2 levels of Grip force
- 3 operators
- 6 tests for every level of grip force
- Push force :100 N \pm 10 N
- 10 s for every test

Moreover a single operator has carried out a test of 30 second in which it has been left full freedom in operating without ties of push and grip force. These first tests in laboratory conditions are carried out to estimate moreover the possibility to applicate the matrix on the handle of vibration tools (in according to objectives of WP6). So here it shows only the acceleration and push oriented grip force time history of the operator which has carried out the single test of 30 s of duration (fig. 6.1).

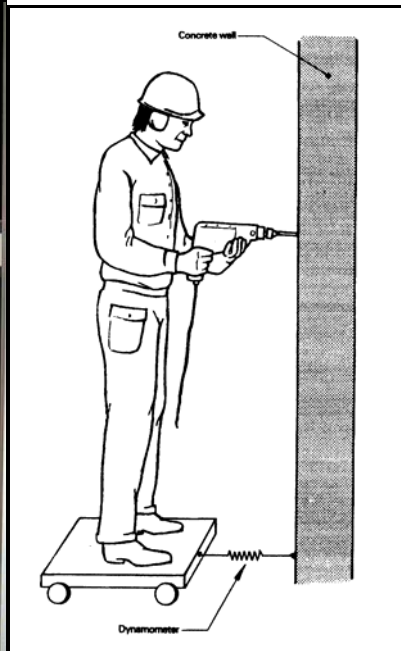

Figura 6.1. Acceleration and push oriented grip force time history of the operator which has carried out the single test of 30 s of duration

It shows also the color map refer to the single frame of the pressure mat during the test (fig. 6.2)

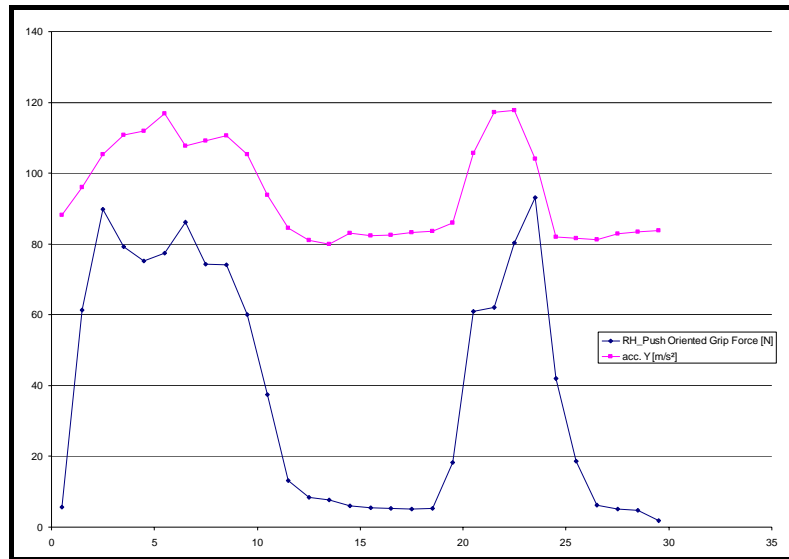

Figura 6.2. Pressure map of the right hand of the operator during the test.

As evident in the diagram of figure 6.1, it exists a qualitative correlation between the course of the acceleration on the handle of the impact drill and the grip force exerted by the operator.

Laboratory tests on chainsaws and brush cleaners (at CNR-IMAMOTER)

IMAMOTER analysed the documents presented at the Project meetings and cooperated with colleagues serving at the UNIVPM on capacitive matrices testing and measurements. Moreover, as contact pressure and grip force measurements on hand-held machines in laboratory test conditions represent the main task for IMAMOTER (see WP6), the analysis has been planned of some parameters useful to better carry out this kind of activity. Within our Project test/measurement collaboration activity, IMAMOTER attended two working meetings at the UNIVPM in May and September 2005. The first aimed at the calibration of the matrix and hardware, shipped back by NOVEL partner after a maintenance phase, and the second in order to check the correctness and availability of the results obtained during tests carried out at IMAMOTER in Turin in July. Since October 2004 several measurements have been carried out on different forestry machines as chain saws and brush cleaners at IMAMOTER Institute in Turin.

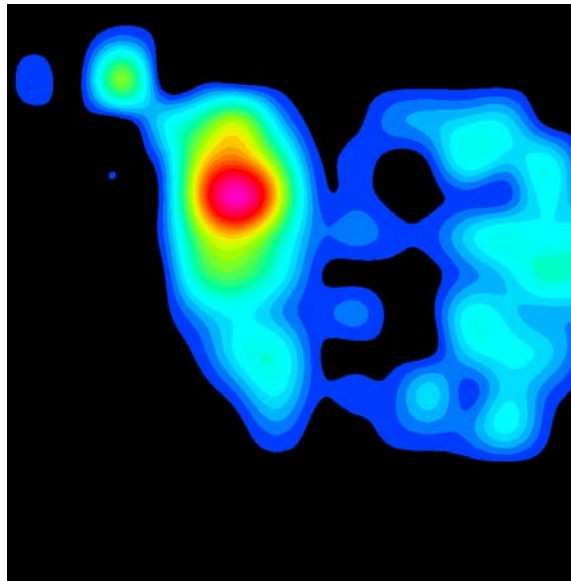

During these tests some problems arose relevant to the matrix flat cables connecting the capacitive elements to the acquisition system. These problems were ascribed to the small diameter of the machine handles and have been overcome by enlarging the original diameters (2,5 cm) of chain saw and brush cleaner handles by means of a double plastic muff (4 cm diameter). That mainly in order to avoid narrow bending between matrix elements.

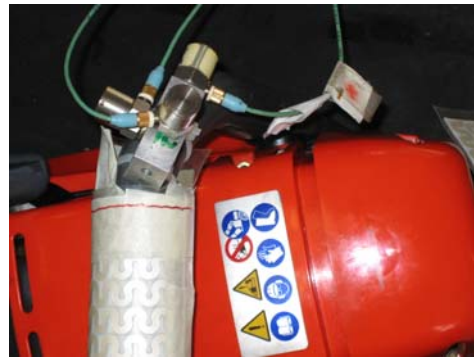

A three axial accelerometer has been fixed on the original handle, close the muff, for the acquisition of acceleration values. This solution produced a different positioning of the matrix. In fact, for a matter of space, we have been forced to wrap the matrix so that it turned out necessary to exclude (by means of the software) the sensors to be referred to the thumb. Moreover an other problem occurred during the measurement period, that is the matrix breaking. It was necessary for us to send the matrix to NOVEL partner in order to be mended. Several tests have been carried out, together with UNIVPM, on forestry machines in July using new software and hardware developed by the UNIVPM. By means of this improvement pressure and vibration time histories have been acquired in parallel on left and right operator hands. During these tests two matrices (one for each handle) and a three axial accelerometer were used at the same time. Owing to the acquisition system available and its channel number limit, a

second three axial accelerometer was not used (see the activity carried out during 2003). All the tests on machines have been carried out complying with the ISO standard requests (ISO 22867: 2004 “Forestry machinery – Vibration test code for portable hand-held machines with internal combustion engine – Vibration at the handles”). So each operator had to set the machine engine at three different operating modes: idling, full load and racing for the chainsaws and idling and racing for the brush cleaners. For each operation mode engine speed has been checked by an engine speed indicator. Each operation mode, for each machine type, has been repeated three time. Nine operators took place for this kind of tests. Signals coming from matrices and accelerometers have been converted and stored in electronic data sheets. Each single sheet includes several columns as:

Time [s];

Right hand: Total Grip Force [N]; Push Force [N]; Push Force Angle [°]; Push Oriented Grip Force [N]; Push Force ISO [N]; Grip Force ISO [N]; Contact Area [cm²]; Contact Area/"Border Sensor Area".

Left hand: Total Grip Force [N]; Push Force [N]; Push Force Angle [°]; Push Oriented Grip Force [N]; Push Force ISO [N]; Grip Force ISO [N]; Contact Area [cm²];

Contact Area/"Border Sensors Area".

Accelerometers:

Acceleration not weighted: X [m/s²]; Y [m/s²]; Z [m/s²]; Total Acc. [m/s²]

Acceleration weighted: Wh X [m/s²]; Wh Y [m/s²]; Wh Z [m/s²]; Total Wh Acc. [m/s²]

As an example, the results obtained during a first analysis phase are reported in the following figures. They refer to operator left hand during the cut phase (full load) executed by chain saw. It is possible to see how a good correlation has been achieved between handle acceleration and total grip force applied. A low grip produces a high acceleration level.

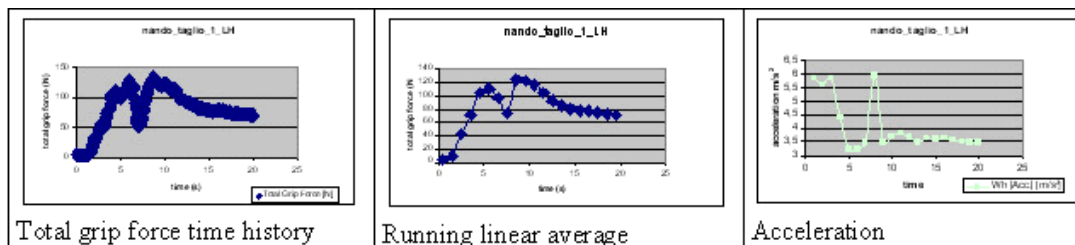

Laboratory tests on hydraulic breakers (at Breakers)

UNIVPM during year 3 has been active in the experimental activities within WP6 in close cooperation with BREAKERS. A week of tests of the matrix sensor on hydraulic breakers was performed in January 2005 on the test bench build during the 2nd year according to the norms series ISO-8662 (figure below).



The matrix of pressure sensors (Fingermat model, 156 sensors) was wrapped on the handle and used to measure the feed and grip forces exerted during a typical ISO 8662:5 test. Tests have been carried out on

a hydraulic impact hammer (LH21, Lifton, DK) mounted on a steel ball energy absorber (ISO 8662-5). An accelerometer and a proper mechanical filter has been placed on the handle. Five male subjects (BMI $24.33 \pm 3.19 \text{ kg/m}^2$, age $38.6 \pm 10.2 \text{ yr}$) have been used during the tests. Feed force measured during tests has been compared with the feed force measured by a scale, according with the ISO 8662:5. Three different kind of tests were performed, changing grip force, push force and both together in order to find correlations between these quantities and the acceleration produced by the tool. As shown in the following table, mean values of push force correspond to high acceleration values, while grip force doesn't seem to have such a close correlation with acceleration.

	Subject	low grip - low push	high grip - low push	low grip - high push	high grip - high push
Acceleration [m/s ²]	sbj_1	35.325	32.619	52.106	72.123
	sbj_2	24.576	21.53	26.037	22.336
	sbj_3	27.716	28.528	32.751	30.457
	sbj_4	30.5	36.32	39.385	44.517
	sbj_5	20.318	23.184	25.677	27.526
Force [N]	push	49.5794	55.8908	111.7252	112.32
	grip	12.6162	119.6478	17.7782	126.442

Data post processing on time histories of forces and acceleration and A.NO.VA tests shows that respecting ISO condition push force is well correlated with acceleration level on 3 of 5 subjects, while holding the hammer with only one hand correlation is higher and arise on all subjects.

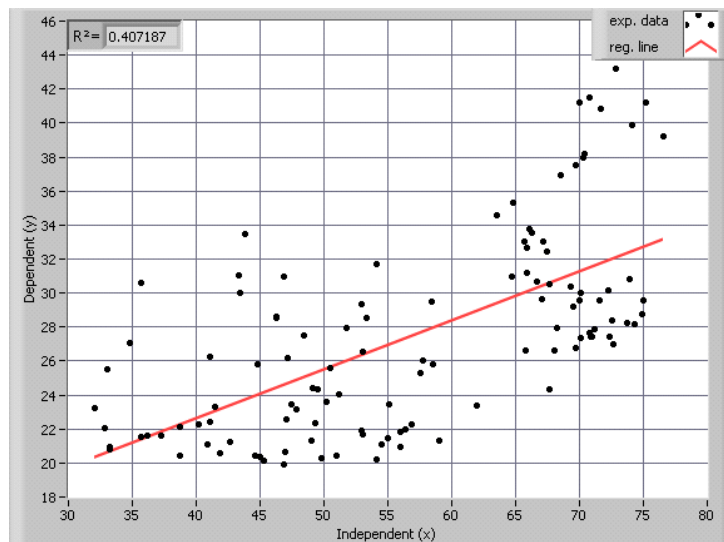

Measurements of coupling forces on pneumatic breakers in the laboratory (at INRS)

The method previously stated was then used to measure the coupling forces on real vibrating tools, in the lab. Two types of tools (fig. 18) were chosen as case study: one ordinary breaker and one antivibration breaker. The latter was equipped with articulated handles. The joint stiffness contributed like a suspension to attenuate the transmission of the vibration.



Figure 18: breakers equipped with an accelerometer and the FINGERMAT matrix.

The tests were carried out according to the standard NF EN 28662-5 [1]. Each breaker was equipped with an accelerometer mounted on a mechanical filter in order to prevent the sensor from overloads (due to shocks). The opposite handles were covered with the FINGERMAT matrix. Acceleration and pressure measurements were synchronized. In parallel, a force platform was used to verify the push force measurement. All the tests were realized with the same operator. The accelerations measured are typical for this category of tools (see figure 19 and 20).

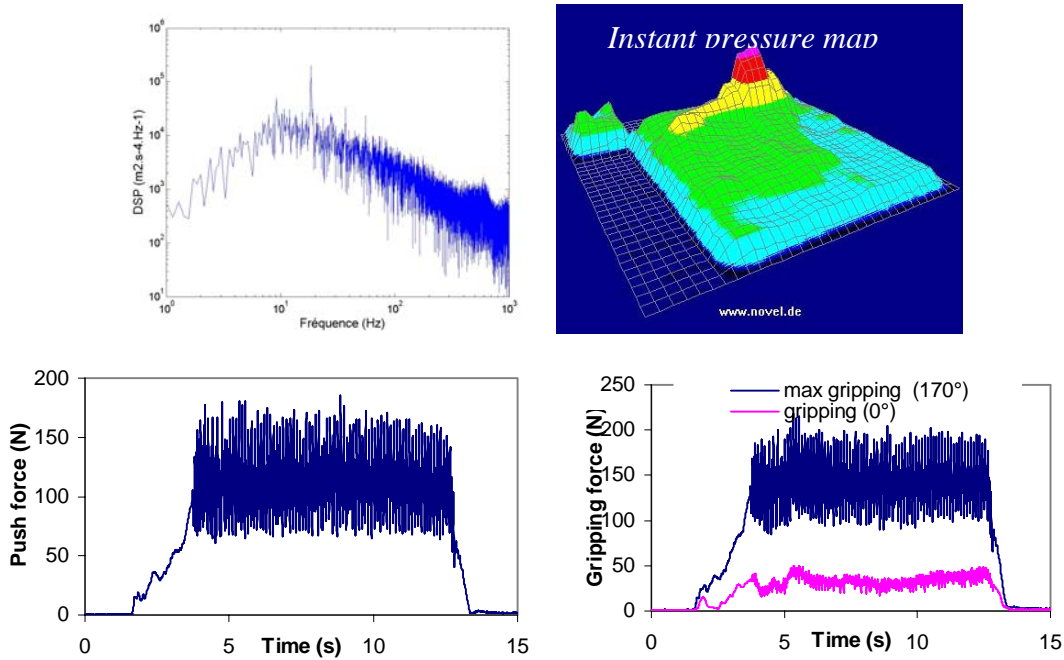
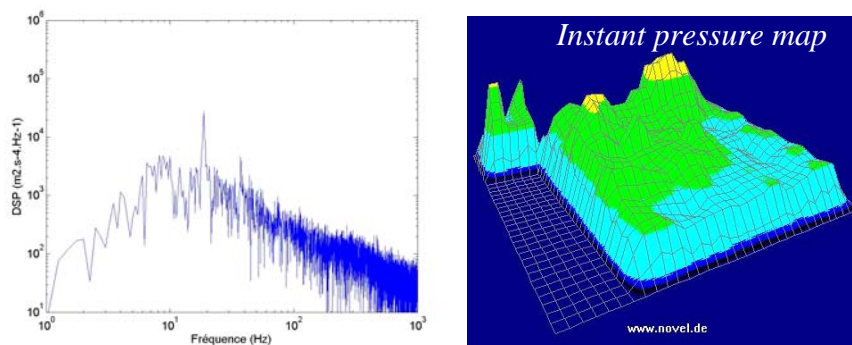

Figure 19: Acceleration, pressure and coupling forces. Ordinary breaker



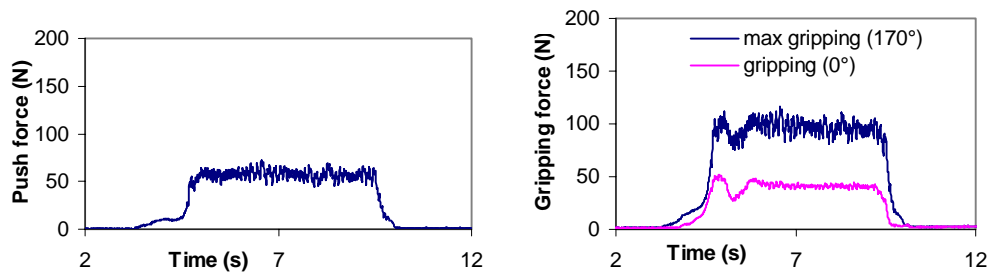

Figure 20: Acceleration, pressure and coupling forces. Antivibration breaker

DSP shows a peak located at about 20 Hz and representative of the hit frequency. Data were weighted according to the standard ISO 5349-1 [2]. The weighted RMS value was measured 32.60 m/s^2 for the ordinary breaker and 7.49 m/s^2 for the antivibration breaker. So, the effect of the handle suspensions was an attenuation of 4.35. Differences may be noted between the mean push forces measured. Higher push and gripping forces were observed with the ordinary breaker. All the tests showed the same tendencies (see table 3 and table 4). The mean push force was 47% higher when using the ordinary breaker and the gripping force was 34% higher. These results can be interpreted as the operator instinctively applies a stronger force with the ordinary breaker. With the antivibration breaker, the optimal push force (= the force that provides most effective impacts) is obtained when the handle is positioned horizontally, i.e. the suspension joint is at mid-angle and equally spaced from the end-stops. With the ordinary breaker, there is no reference and the operator instinctively feels that the higher the push the stronger the impacts, which is not true. As a result, exerting an intensive push requires a strong grip. That is the reason why the gripping force was also higher in the case of a ordinary breaker. The operator was standing on the force platform during the tests. The platform measured his weight. The push forces listed in table 3 and table 4 (2nd line) were obtained from the difference of the operator's weight when holding the breaker and before holding it, the difference being attributed to the vertical push. In practice, the platform was set to zero when the operator stood on it just before the test, so that the push force was directly delivered. Push force and gripping force computed from pressure mapping are representative of one handle only. So the push force must be compared to half the force measured by the force platform. The assumption was made that both hands exerted the same coupling forces. The results show a very good correlation between the two measurements (platform measurement and pressure integration) : less than 6 % of difference in the case of the ordinary breaker and between 3 and 28% in the case of the anti-vibration breaker.

Ordinary breaker	Test 1	Test 2	Test 3	Test 4	Test 5	Test 6	Test 7	Mean value
Push Force (N)	102	120	136	147	140	128	140	130.43
Kistler Platform Force (N)	205	238	263	279	268	256	276	255.00
Grip Force ISO 15230 (N)	78	69	72	71	73	82	77	74.57
Max Grip Force (N)	177	187	206	216	211	207	216	202.86
Acceleration (RMS) m/s²	30.50	29.40	26.50	27.00	27.40	28.40	27.70	28.13

Table 3: mean values of coupling forces measured with the ordinary breaker.

ANTIVIBRATION BREAKER	Test 1	Test 2	Test 3	Test 4	Test 5	Mean value
Push Force (N)	85	88	90	90	88	88.20
Kistler Force Platform (N)	205	206	140	158	171	176.00
Grip Force ISO 15230 (N)	64	55	54	54	54	56.20
Max Grip Force (N)	168	144	146	146	144	149.60
Acceleration (RMS) m/s²	5.50	5.94	5.44	6.00	6.01	5.78

Table 4: mean values of coupling forces measured with the antivibration breaker.

The beneficial effect of the suspension may be also noted by comparing the time histories of the coupling forces. It is clear that the application of forces is more constant and is less perturbed by oscillations when the antivibration breaker is used. It is worth being noted that the gripping force computed according to the draft standard ISO 15230 is significantly lower than the max gripping force computed according to the definition given in equation (3). Using equation (2) with an angle α of 0° is equivalent to the definition given in ISO 15230. the max gripping force was always obtained for an angle α of 10° . This means that the gripping is very sensitive to the angle of observation.

WP 7: Tests of sensors at typical workplace.

Workpackage Manager: HVBG/BGIA; Partners involved: HVBG/BGIA, UNIVPM, CNR-IMAMOMTER, BREAKERS A/S and NOVEL.

Objective

Aim of WP7 was to test the pressure sensors realised in the previous WPs in typical testing conditions and in particular:

- Testing of measurement equipment under field conditions
- Development of a measuring method for field measurements
- Suggestions for improvement of measuring equipment
- Supply of measurement results in practice for medical studies

Scientific and technical description of WP7.

In WP7 a number of tests has been performed by HVBG/BGIA, in close collaboration with UNIVPM, with real operating conditions. Tools were chosen as representative of very different classes, because it was intended to demonstrate how sensors work with a large variety of tools. The following tools were tested:

- Hydraulic and electrical road breakers
- Rammer
- Grinder

The hardware and software for simultaneous acquisition of contact forces by the FINGERMAT and of acceleration of the tool was provided by UNIVPM.

In general, correlation between measured acceleration and coupling actions is observed. Below is reported a pair of correlation diagrams derived by a series of tests.

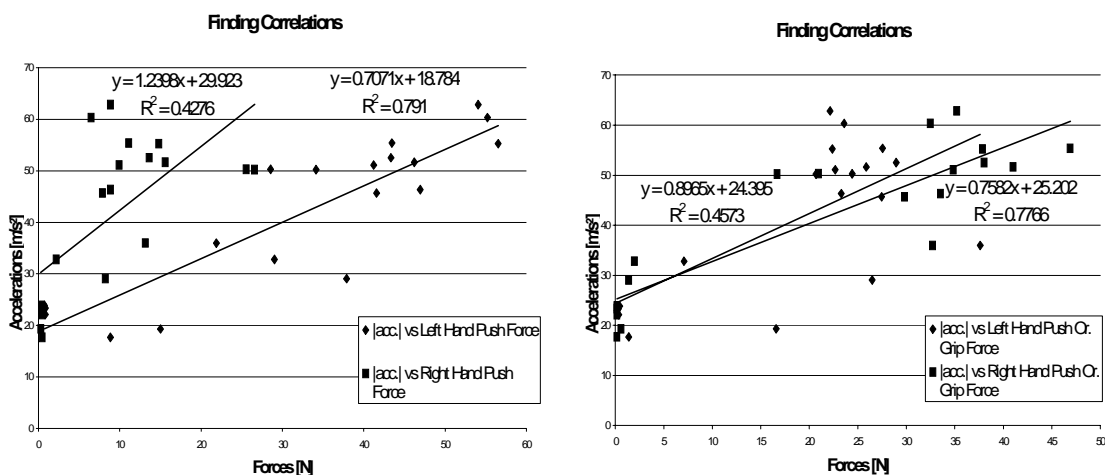

In the following section 3 detailed reports of tests sessions of sensor matrix at typical workplaces are reported.



Registration- No.: 2005 20206-01

Administrator: M. Söntgen/ G. Schmitz

Measurement report

1. General information:

Day of measure: 26.04.2005

BG/ customer: BGIA

Factory/address: Bayerische Bau- Akademie, Ansbacher Strasse 20, 91555 Feuchtwangen

Tel.: 09825/ 9002-0, Fax.: 09825/ 9002-909

Participants at measurement: Mr. Reichelt (test person); Mr. Enrico Concettoni (UNIVPM, Ancona);
 Mr. Kaulbars, Mr. Söntgen, Mr. Schmitz (BGIA)

Measurement no.																	
0	0	0	4	3	0	1	9	4	/	0	0	.	0	0	5	0	5
1	2	3	4	5	6	7	8	9	10	11	12	13	14	15	16		
Consecutive number																	

2. Description of the workplace :

Environmental influences:

indoor outdoor flue gas dust noise: dB (A)

Temperature: 10-13 °C relative. humidity: 60- 75 %

Work area: Test field of the Company Bayerische Bau-Akademie

Notes: _____

3. Specification of the machine

Machine designation (generic term): Breaker (Subgroup): Pavement breaker

Manufacturer: Company: Lifton, Aalborg DK

Type: LH 21 Serial no.: --- Year of manufacture: 2004

Condition: ?????? Weight: 24,5 (Kg) Drive system: hydraulic

Impact energy: 85 Joule Rated speed / Rated impact no.: 1320- 2160 min⁻¹

Air pressure according as manufacturer/ working: 105- 125/ - (bar)

Grip: surface of the tool round oval T-Form D-Form P-Form

Grip material: synthetic jacket grip synthetic (Full material) wood grip metal

Notes: _____

4. Description of the vibration protection system

Vibration protecting: yes- / no

Handle jacket: yes / no- Material: vulcanised rubber

AV-System: yes- / no Type:

Notes:

5. Details of measurement

Mode of measurement: tool measurement work place measurement

Coordinate system: hand oriented relating to the tool (with fix measurement point)

relating to the tool (without fix measurement point)

Method of attachment single bonded screwed

of the accelerometer: triaxial with clamping piece:

Mechanical filter: yes no

Location of the surface of the machine * main handle support handle

measurement point: at the tool

Notes: Mounting with a plastic adapter;

* For location of the measurement point: Main handle on right side



Annex of the measurement report !

Measurement report no.: 200520206-01, Ltd. – No.: H196 /04.1 -/04.5
 Factory/address: Bayerische Bau-Akademie, Feuchtwangen
 Working tool: Hydraulic breaker

Results of push and grip force measurements

Measuring-no.:	V194 /04.1 - /04.5
Machine designation:	Pavement breaker
Manufacturer:	Lifton
Type / Model:	LH21 / Serial no.: 213816
Insertion tool:	pointed chisel (short format)
working procedure:	to break open concrete
Notes:	measurements with fingermat_06 (U NIVPM) at support handle (left)

Subject:	Subject 1, Mr. Reichert		Measuring point: Support handle (left)			
	push and grip force measurement (mean values in N)					
Measuring no.:		TOTAL grip force	Push force	Push oriented grip force	Push force ISO	Grip force ISO
V194/ 04.1	Mean	475	94	129	77	128
V194/ 04.2	Mean	487	119	118	111	120
V194/ 04.3	Mean	390	96	101	83	97
V194/ 04.4	Mean	469	102	120	58	134
V194/ 04.5	Mean	426	91	106	73	110
Arithmetic mean value	Mean	443	102	111	81	115





Annex of the measurement report !

Measurement report no.: 200520206-02, Ltd. no.: H196 /10.1 -/10.6
 Factory/address: Bayerische Bau- Akademie, Feuchtwangen
 Working tool: Hydraulic breaker

Results of push and grip force measurements

Measuring-No.:	V194 /10.1 - /10.6
Machine designation:	Pavement breaker
Manufacturer:	HILTI
Type / Model:	TE 905-AVR
Insertion tool:	pointed chisel (short format)
Working procedure:	to break open concrete
Notes:	measurements with fingermat_06 (UNIVPM) at Main handle and fingermat_05 (BG IA) at Support handle

Subject:	Subject 1, Mr. Reichert		Measuring point: Main handle			
	push and grip force measurement (mean values in N)					
Measuring-no.:		TOTAL grip force	Push force	Push oriented grip force	Push force ISO	Grip force ISO
V194/ 10.1	Mean	620	171	165	166	166
V194/ 10.2	Mean	732	158	211	151	219
V194/ 10.3	Mean	545	71	172	66	180
V194/ 10.4	Mean	620	164	163	158	167
V194/ 10.5	Mean	527	115	144	105	158
Arithmetic mean value	Mean	609	135	171	129	178

Subject:	Subject 1, Mr. Reichert		Measuring point: Support handle			
	push- and grip force measurement (mean values in N)					
Measuring no.:		TOTAL grip force	Push force	Push oriented grip force	Push force ISO	Grip force ISO
V194/ 10.1	Mean	476	111	118	91	96
V194/ 10.2	Mean	553	141	127	105	108
V194/ 10.3	Mean	450	106	105	86	94
V194/ 10.4	Mean	387	73	98	61	85
V194/ 10.5	Mean	328	64	78	39	75
Arithmetic mean value	Mean	439	99	105	76	91





Registration- No.: 2005 20206-03

Administrator: M. Söntgen/ G. Schmitz

Measurement report

1. General information :

Day of measure: 20.07.2005

BG / customer: BGIA

Factory/ address: Hamburger Aluminiumwerke GmbH, Hamburg

Participants at measurement: Mr. Reichelt (test person); Mr. Enrico Concettoni (UNIVPM, Ancona);
 Mr. Kaulbars, Mr. Söntgen, Mr. Schmitz (BGIA, Sankt Augustin)

Measurement- No.															
0 0 0 4 3					0 1 9 6 / 0 0 . 0					0 5 0 5					
1	2	3	4	5	6	7	8	9	10	11	12	13	14	15	16
Consecutive number															

2. Description of the workplace :

Environmental influences:

inside out of doors flue gas dust noise: dB (A)

temperature: ~ 20 °C relative. humidity: - %

Work area: kiln engineering

Notes: the equipment was not working

3. Specification of the machine

Machine designation (generic term): compressor (Subgroup): pneumatic rammer

Manufacturer: Frölich & Klüpfel pneumatics technical company, Wuppertal (Germany)

Type: ST 2 P2 G Serial- No.: 19035 Year of manufacture: 2003

Condition: ?? Ø ??? Weight: 13,15 (Kg) Drive system: pneumatically

Impact energy: ~~Rated speed~~ / Rated Impact No.: 800 min⁻¹

Air pressure according as manufacturer/ working: 6,0 / - (bar)

Grip: surface of the tool round oval T-Form D-Form P-Form

Grip material: synthetic jacket grip synthetic (Full material) wood grip Metal

Miscellaneous: Volumetric flow rate, Q = 650 l/ min.

4. Description of the vibration protection system

Vibration protecting: yes / ~~no~~

Handle jacket: yes / no Material:

AV-System: yes / ~~no~~ Type:

Notes: noise and reaction damping

5. Details of measurement

Mode of measurement: tool measurement work place measurement

Coordinate system: hand oriented relating to the tool (with fix measurement point)

relating to the tool (without fix measurement point)

Method of attachment single bonded screwed

of the accelerometer: tri axial with clamping piece:

Mechanical filter: yes no

Location of the Surface of the machine main handle support handle

Measurement point: at the tool

Notes: mounting with a plastic adapter



Annex of the measurement report !

Measurement report No.: 200520206-03, Ltd. – No.: H196 /01.4 -/02.4
 Factory/ address: Hamburger Aluminium- Werke GmbH, Hamburg
 Working tool: pneumatic rammer; Manufacturer: Frölich & Klüpfel, type ST2P2G
 Working procedure: to stamp Aluminium mass

Results of push and grip force measurements

Measuring-No.:	H196 /01.4 - /01.8
Machine designation:	rammer
Manufacturer:	Frölich & Klüpfel
Type / Model:	ST2P2G
Insertion tool:	stamp tool
working procedure:	to stamp Aluminium mass
Notes:	measurements with Fingermat_09 (UNI VPM) right hand at Main handle and Fingermat_13 (BGIA) left hand at Support handle

Subject:	Subject 1, Mr. Riemer		Measuring point: Main-handle			
Push- and Grip force measurement (mean values in N)						
Measuring-no.:		total grip force	Push force	Push oriented Grip force	Push force ISO	Grip force ISO
V194/ 01.4	mean	198	17	55	13	77
V194/ 01.5	mean	274	40	72	35	106
V194/ 01.6	mean	259	46	67	40	106
V194/ 01.7	mean	298	63	70	58	128
V194/ 01.8	mean	211	42	50	38	88
Arithmetic mean value	mean	248	42	63	37	101

Subject:	Subject 1, Mr. Riemer		Measuring point: Support-handle			
Push- and Grip force measurement (mean values in N)						
Measuring-no.:		total Grip force	Push force	Push oriented Grip force	Push force ISO	Grip force ISO
V194/ 01.4	mean	348	39	88	23	110
V194/ 01.5	mean	378	41	94	26	112
V194/ 01.6	mean	350	34	92	24	94
V194/ 01.7	mean	343	43	90	32	89
V194/ 01.8	mean	232	27	62	18	62
Arithmetic mean value	mean	330	37	85	25	93





Registration- No.: 2005 20206-04

Administrator: M. Söntgen/ G. Schmitz

Measurement report

1. General information:

Measurement- No.																	
0	0	0	4	3	0	1	9	8	/	0	0	.	0	0	5	0	5
1	2	3	4	5	6	7	8	9	10	11	12	13	14	15	16		
Consecutive number																	

Day of measure: 28.09.2005

BG/ customer: BGIA

Factory/ address: Heideberger Druckmaschinen AG, 69168 Walldorf- Wiesloch

Participants at measurement: Mr. Rabehl (test person); Mr. Enrico Concettoni (UNIVPM, Ancona);
 Mr. Kaulbars, Mr. Söntgen, Mr. Schmitz (BGIA, Sankt Augustin)

2. Description of the workplace :

Environmental influences:

- indoor outdoor flue gas dust noise: dB (A)
- temperature: ~ 20 °C relative. humidity: - %

Work area: mechanical workshop

Notes:

3. Specification of the machine

Machine designation (generic term): grinder (Subgroup): angle grinder
 Manufacturer: Frölich & Klüpfel Drucklufttechnik GmbH, Wuppertal (Germany)
 Type: GWS 24/ 180 H Serial- No.: 0601853403 1920000017 Year of manufacture: 2001
 Condition: ?? Ø ??? Weight: 5,1 (Kg) Drive system: electrical

Rated power: 2400 (W) Rated speed / Rated Impact— No.: 8500 min⁻¹
 Air pressure according as manufacturer/ working: - / - (bar)

- Grip: surface of the tool round oval T-Form D-Form P-Form
- Grip material: 1. synthetic jacket grip synthetic (full material) wood grip metal
- Notes: 1. main handle; support handle as a plastic hollow piece or plastic pipe standard support grip

4. Description of the vibration protection system

Vibration protecting: ~~yes~~ / no
 Handle jacket: ~~yes~~ / no Material:
 AV-System: ~~yes~~ / no Type:
 Notes:

5. Details of measurement

- Mode of measurement: tool measurement work place measurement
- Coordinate system: hand oriented relating to the tool (with fix measurement point)
 relating to the tool (without fix measurement point)
- Method of attachment of the accelerometer: single bonded screwed
 tri axial with clamping piece:
- Mechanical filter: yes no
- Location of the measurement point: surface of the machine main handle support handle
 at the tool
- Notes: mounting with a plastic adapter



Annex of the measurement report !

Measurement report no.: 200520206-04, Ltd. – no.: H198 /08.0 -/09.5
 Factory/ address : Heidelberger Druckmaschinen AG, 69168 Walldorf- Wiesloch
 Working tool: angle grinder

Results of push and grip force measurements

Measuring-No.:	H198 /08.0 - /09.5
Machine designation:	angle grinder
Manufacturer:	Bosch
Type / Model:	GWS 24/180
Insertion tool:	rough grinding wheel
Working procedure:	grinding steel
Notes:	measurements with fingermat_09_(UNI VPM) right hand at main handle and fingermat_1305 (BG IA) at support handle

Subject:	subject 1, Mr. Reichert	Measuring point: main handle
Push and grip force measurement (mean values in N)		

Measuring no.:		Total grip force	Push force	Push oriented grip force	Push force ISO	Grip force ISO
H198/ 08.0	mean	188	61	46	61	108
H198/ 08.1	mean	177	65	39	65	105
H198/ 08.2	mean	164	61	35	61	97
H198/ 08.3	mean	141	53	31	53	85
H198/ 08.4	mean	140	50	32	50	82
H198/ 08.5	mean	135	49	30	49	79
Arithmetic mean value	mean	158	57	36	56	92

Subject:	subject 1, Mr. Reichert	Measuring point: support-handle
Push and grip force measurement (mean values in N)		

Measuring-no.:		Total grip force	Push force	Push oriented grip force	Push force ISO	Grip force ISO
H198/ 09.0	mean	267	46	69	42	76
H198/ 09.1	mean	239	45	64	44	68
H198/ 09.2	mean	233	46	66	45	65
H198/ 09.3	mean	213	55	53	55	53
H198/ 09.4	mean	200	47	51	47	51
H198/ 09.5	mean	206	53	50	52	51
Arithmetic mean value	mean	226	49	105	47	61



WP 8: Tests of sensors for ergonomic and medical applications.

Workpackage Manager: ISVR; Partners involved: ISVR and NOVEL.

Objective

WP8 had the objective to evaluate the possible application of the sensors for ergonomic and medical studies, and in particular for investigations of the effects of contact pressure on mechanical impedance of the hand, energy absorption in the hand and vascular effects.

Scientific and technical description of WP8.

WP 8 was designed to investigate the application of pressure sensitive sensors for biodynamic and medical studies. Experimental studies were conducted to determine the relationship between contact pressure and the vascular and biodynamic responses of the hand. The vascular studies investigated how finger blood flow is dependent on pressure and whether contact pressure distribution should be used in the assessment of the risks of occupational exposure to hand-transmitted vibration. The biodynamic studies were intended to investigate the use of the pressure sensors to determine how mechanical impedance and the energy absorbed in the hand varied with contact pressure.

Vascular studies

Objective of the vascular studies was to investigate whether the vasoconstriction in the finger caused by vibration of the finger is dependent of the applied pressure. Prior to the studies it was known that local vibration of the fingers caused vasoconstriction in the fingers exposed to vibration and also in the contralateral hand. It was not known whether the contact force between vibration and the tissues of the fingers and hand would affect the response to vibration. The research involved 3 experimental studies:

- *Experiment 1: Finger contact with forces of 2 N, 5 N, and no force;*
- *Experiment 2: Palm contact with forces of 5 N, 20 N, and no force;*
- *Experiment 3: Finger contact with 2 N force*

Experiment 1: Finger contact with 2 N, 5 N, and no force

Ten subjects attended 11 sessions on separate days. Each vibration session consisted of 5 successive 5-minute periods: (i) no force; (ii) force and no vibration; (iii) force and vibration; (iv) force and no vibration; (v) no force and no vibration. During periods (ii) to (iv), the push force was applied by the middle phalanx of the right middle finger at either 2 N or 5 N. During period (iii) the right middle finger was exposed to vibration at either 31.5 Hz (at 4 or 16 m s⁻² r.m.s.) or 125 Hz (at 16 or 64 m s⁻² r.m.s.). One session was a control condition which was the same as the vibration conditions except for period (iii) which was force no vibration. Finger blood flow was measured in the exposed right middle finger, the non-exposed left middle finger and the non-exposed right little finger. Figure 1 shows the experimental set up for generating the vibration, controlling the contact force, and measuring finger blood flow. It was hypothesised that the vasoconstriction in the finger caused by vibration of the finger is independent of the applied force at 2 N and 5 N.

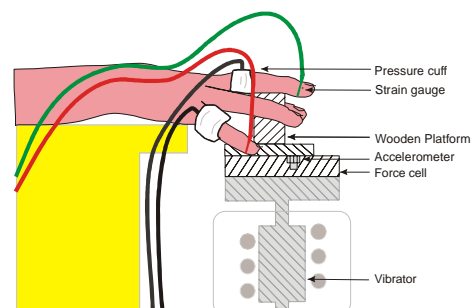

Figure 1 Experimental set up for generating the vibration, controlling the contact force and measuring finger circulation in experiment 1.

Figure 2 shows that the 2 N and 5 N force reduced finger blood flow in the exposed finger. Vibration caused a reduction in blood flow compared to finger blood flow during pre-exposure force. The 5 N force produced a stronger reduction in blood flow during vibration than the 2 N force.

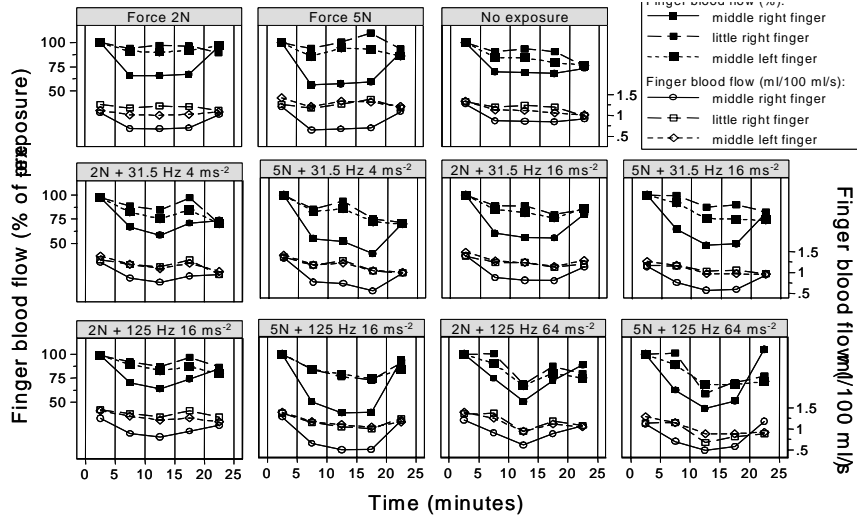

Figure 2 Finger blood flow during the five periods of the control and vibration conditions in experiment 1: i) no force; ii) force and no vibration; iii) force and vibration (no vibration in control condition); iv) force and no vibration; v) no force and no vibration.

Experiment 2: Palm contact with 5 N, 20 N, and no force

Ten subjects attended five sessions on separate days. Two vibration sessions consisted of five successive 5-minute periods: (i) no force; (ii) force and no vibration; (iii) force and vibration; (iv) force and no vibration; (v) no force and no vibration. During periods (ii) to (iv) the push force was applied by the right palm at either 5 N or 20 N. During period (iii) the right palm was exposed to vibration at 125 Hz (at 16 or 64 ms⁻² r.m.s.). In two control sessions, period (iii) consisted of force with no vibration. One condition was a ‘rest’ control condition consisting of five 5-minute periods of no force and no vibration. Finger blood flow was measured in the exposed right middle and little fingers and the non-exposed left middle finger. It was hypothesised that the vasoconstriction in the finger caused by vibration of the hand is independent of the applied force at 5 N and 20 N. Figure 3 shows that the 20 N force applied to the palm reduced finger blood flow in both fingers on the exposed hand. Vibration caused a reduction in finger blood flow compared to finger blood flow during pre-exposure to force without vibration in all fingers. The 20 N force produced a stronger reduction in blood flow during vibration than the 5 N force in all fingers.

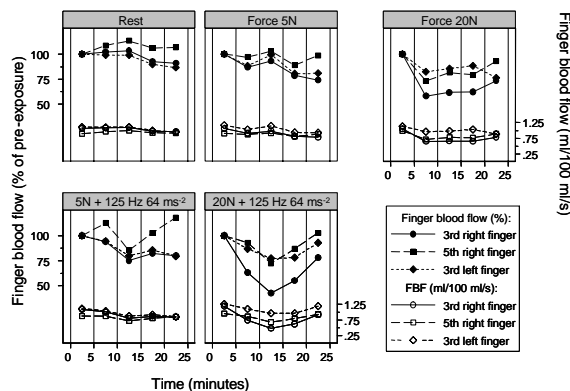

Figure 3 Finger blood flow during the 5 periods of the control and vibration conditions: i) no force; ii) force and no vibration; iii) force and vibration (no vibration in control condition); iv) force and no vibration; v) no force and no vibration.

Experiment 3: Finger contact with 2 N force

Ten subjects attended two sessions, each lasting 62 minutes, on separate days. A vibration condition consisted of five successive periods: (i) no push force, (ii) 2 N push force, (iii) 2 N push force while the magnitude of 125 Hz vibration increased linearly in magnitude from 0 to 88 ms⁻² r.m.s. (unweighted), (iv) 2 N push force, (v) no push force. During periods (ii) to (iv) the medial phalanx of the right middle finger was exposed to the 2-N force. A control condition was similar but without vibration during the third period. Finger blood flow was measured every 30 seconds in the right middle finger, right little finger and left middle finger. Figure 4 shows the finger blood flow in the exposed finger during the five periods of each experimental session. The application of the 2 N push force reduced finger blood flow in the exposed finger compared to pre-exposure levels. Increases in vibration magnitude progressively reduced finger blood flow compared to blood flow during 2 N force. A reduction in blood flow was found in non-exposed hands at higher vibration magnitudes.

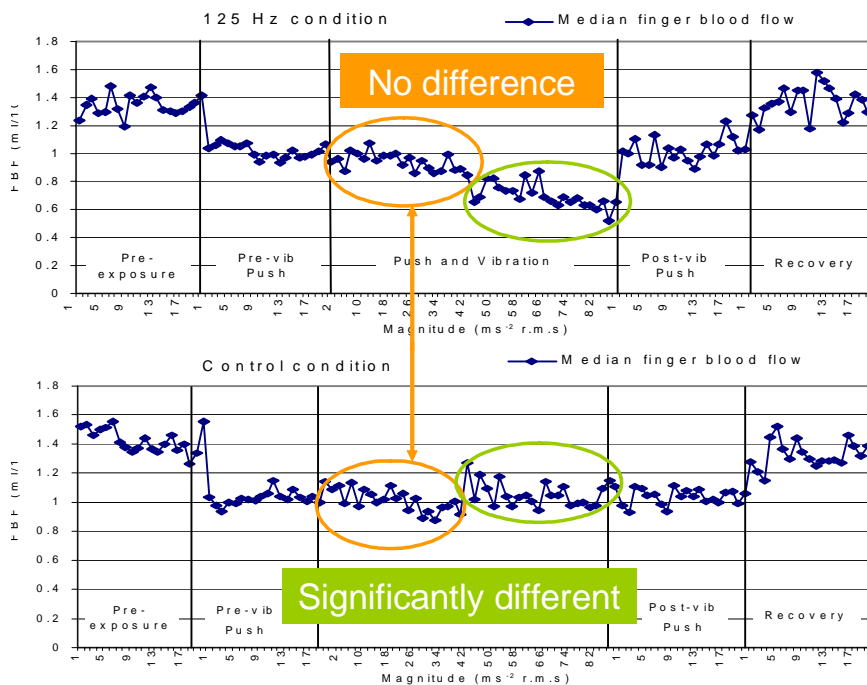

Figure 4 Finger blood flow during the five periods of the control and vibration condition: (i) no force; (ii) force and no vibration; (iii) force and vibration (no vibration in control condition); (iv) force and no vibration; (v) no force and no vibration.

The studies confirmed that vibration of either the finger or palm reduces finger blood flow. The results also show that the application of force to the palm or the finger can reduce finger blood flow. The force can also modify the vasoconstriction caused by vibration applied to the finger or palm. In summary:

- 2 N and 5 N forces applied to the finger reduced blood flow;
- 20 N force applied to the palm reduced finger blood flow;
- vasoconstriction in the finger caused by vibration depended on the applied force;
- the greater the applied force, the greater the reduction in finger blood flow, both with and without vibration.

Ergonomic studies

The objective of the ergonomic studies was to investigate the extent to which force affected the biodynamic responses of the hand. It was the original intention to use the pressure sensors for this purpose, but tests conducted during the studies raised questions as to the accuracy of the sensors over the full frequency range it was desired to investigate. A decision was therefore taken to proceed with the studies using conventional force cells.

The research involved three experimental studies:

- Experiment 1: effect of push force on the apparent mass of the hand;
- Experiment 2: effect of push force on the absorbed power of the hand;
- Experiment 3: effect of force on the transmission of vibration through glove materials to the palm of the hand.

Experiments 1 and 2: effect of force on apparent mass and energy absorption of the hand

Hand apparent mass was measured using the apparatus in Figure 1. With forces of 10, 20 and 40 N, acceleration was measured on the platform and at a palm adapter. The subjects adopted a flat palm-down hand posture with the palm adapter in the centre of the palm and in-line with the top platform secured to the force cell (Figure 1).

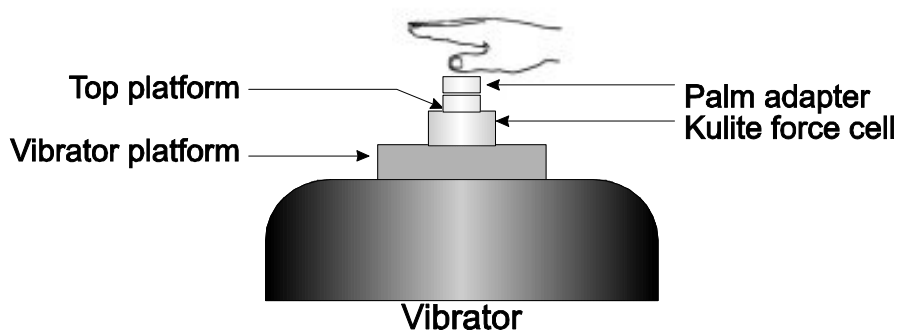

Figure 1 Schematic diagram of apparatus for measurement of the apparent mass of the hand.

The dynamic force measured at the vibrator platform secured to the force cell and the acceleration measured in the palm adapter were used to obtain the apparent mass of the hand after mass cancellation. Mass cancellation was achieved by obtaining the apparent mass of the force cell, top plate and palm adapter securely attached to each other, from a 'free run'. The mass was then multiplied by the acceleration time history for each test carried out with a subject and the resulting force subtracted from the dynamic force measured for that test. Twelve male subjects aged between 20 and 45 years participated in the experiment. The data have been analysed to assess the effect of push force on the apparent mass (ratio of dynamic force to acceleration as a function of frequency) and the absorbed power (the force multiplied by velocity as a function of frequency). Figure 2 illustrates the median apparent masses with push forces of 10, 20, and 40 N over the frequency range 5 to 500 Hz.

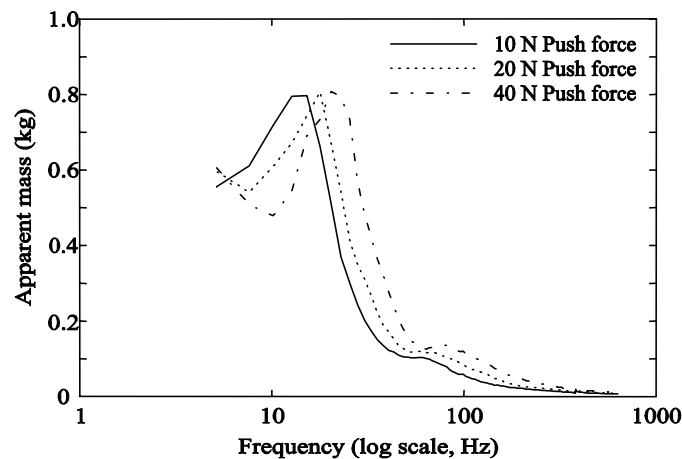

Figure 2 Effect of push force on the median apparent mass at the palm of the hand for 12 subjects obtained with a circular contactor of diameter 25 mm.

There were similar responses in the individual subjects. With increased force, the resonance frequency increased and the magnitude of the apparent mass at the principal resonance increased. The changes are consistent with increased stiffness in the hand with the greater push forces. The median results for the absorbed power indicated that as the push force increased, the magnitude of the absorbed power reduced. This may also be due to a stiffening of the hand with the higher push forces.

Experiment 3: effect of force on the transmission of vibration through glove materials to the palm of the hand

The effects of push force on the apparent mass of the hand and the vibration transmissibility of glove materials to the palm of the hand were measured in the laboratory. The measured material transmissibility was then compared with predictions of the transmissibility derived from the measured apparent mass at the palm of the hand and the measured dynamic stiffness of the material. The study was performed with three materials taken from current gloves: material 1 was a layer of gel inside two layers of foam, material 2 was a gel, and material 3 was densely packed foam. The apparent masses, transmissibilities and dynamic stiffnesses were determined as a function of vibration frequency over the range 5 to 500 Hz with preload forces of 10, 20 and 40 N. The apparent masses (obtained from experiment 1) and transmissibilities were obtained with 12 male subjects. A simple impedance model of the material-hand dynamic system was then used to predict the transmissibility of each material for each force and each subject. The median measured and predicted transmissibilities over the 12 subjects for the three materials are shown in Figures 3 and 4. The median measured transmissibilities of the materials to the palm of the hand obtained with the twelve subjects with push forces of 10, 20 and 40 N are shown in Figure 3. For material 1, there was an overall increase in transmissibility at most frequencies between 50 and 500 Hz as the push force was increased, although the effect of force was inconsistent at frequencies around 200 Hz (Figure 3). For material 2, there was a similar trend to that of material 1, with inconsistent effects of force between 100 and 250 Hz. Again, for material 3, although the transmissibility increased with increasing force at low and high frequencies, the effects of force were variable at intermediate frequencies.

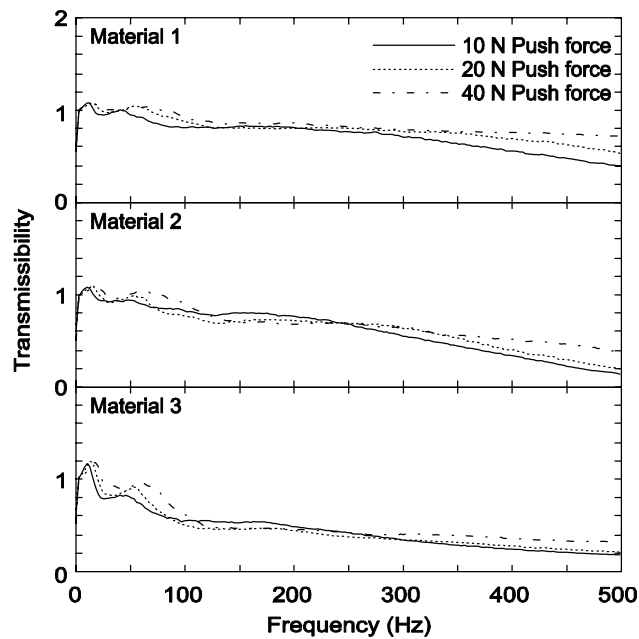

Figure 3 Effect of push force on median measured transmissibilities to the palm of the hand for three types of material with 12 subjects with 10, 20 and 40 N force

Figure 4 shows the median material transmissibilities predicted for the twelve subjects with 10, 20 and 40 N forces and may be compared directly with the measurements in Figure 3. Like the measured transmissibilities, the predicted transmissibilities tend to increase with increased push force at lower and higher frequencies but show less effect of force at intermediate frequencies.

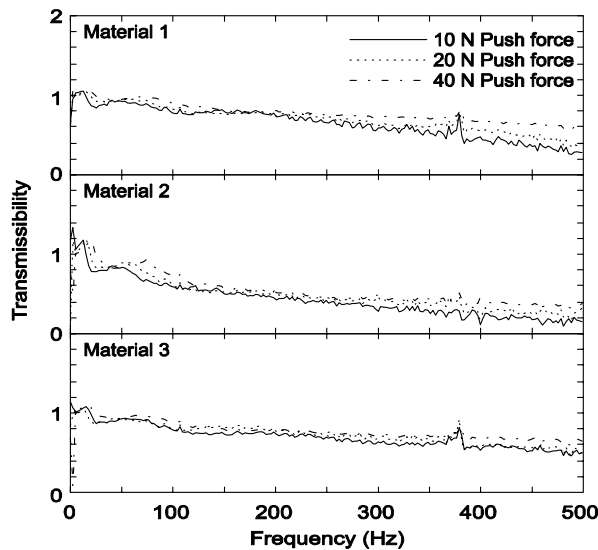

Figure 4 Effect of push force on predicted median transmissibilities to the palm for three types of material with 10, 20 and 40 N force (predictions from the measured apparent masses of 12 subjects)

Conclusions from biodynamic studies

The biodynamic studies show that force affects the apparent mass of the hand, the absorbed power in the hand and the transmission of vibration through glove materials. In summary:

- The primary resonance of the apparent mass of the palm of the hand increased with increasing force applied at the palm;
- The absorbed power at the palm reduced as the push force increased;

- The dynamic stiffness of materials currently used in anti-vibration gloves increased with increasing applied force;
- The transmission of vibration through materials used in current anti-vibration gloves to the palm of the hand varied according to the force applied to the material;
- An impedance model of the vibration transmissibility of anti-vibration glove materials to the palm of the hand yields encouraging results – modelled and measured transmissibilities showed similar trends with changes in the push force.

General Conclusions for WP 8

The vascular and biodynamic studies conducted in this workpackage show that the applied force, and therefore contact pressure, at the fingers or palm, alters vascular and biodynamic responses. The changes may be partly caused by variations in static pressure and partly by changes in dynamic forces. The biodynamic and physiological responses of the hand are very complex and cannot be fully understood from the studies undertaken within WP 8. The general conclusions are that further experimental studies of the responses of the hand to vibration should control and monitor the forces and pressures of contact with the hand. Further studies are needed to develop an improved understanding of the mechanisms by which the forces and pressures moderate biodynamic and vascular responses to vibration. Since the forces and pressures have been found to alter vascular and biodynamic responses in experimental conditions it can be assumed that they also alter responses during occupational exposure to hand-transmitted vibration. It therefore seems appropriate to seek to measure these forces for work with hand-held vibratory tools. With improved understanding it may be possible to reduce the risks of injury from hand-transmitted vibration by optimisation of the pressures between the hands and the vibrating surfaces of powered hand tools.

WP 9: Standardisation issues.

Workpackage Manager: UNIVPM; Partners involved: UNIVPM, INRS, HVBG/BGIA, CNR-IMAMOTER, ISVR and NOVEL.

Objective

To contribute to a standard dealing with specifications useful to measure coupling forces and pressure and describing specifications of equipment and calibration method.

Scientific and technical description of WP3.

The partnership has actively worked to establish a formal contact with CEN, especially with CEN-TC-231-WG2 “Hand-arm vibration”, which is the CEN Working Group with a specific interest into the topic of the VIBTOOL project. VIBTOOL was endorsed by CEN-STAR and it is financed under a dedicated call for research in support of standardization.

A first formal contact made on January 2004 by UNIVPM as coordinator with Mr. Pirlet at CEN in Brussels. Then during the project work on standardization issues has started involving mainly some of the partners (INRS, HVBG/BGIA, ISVR, UNIVPM and IMAMOTER) with the aim to draw elements for a standard dealing with specifications useful to measure coupling forces and pressure and describing specifications of equipment and calibration method. In September 2004 – prof. N.Paone from UNIVPM has contacted mr. D.Hansen secretary of TC-231 to establish a formal link with CEN; the following partners have been indicated as experts within VIBTOOL project:

- dr. Manu Donati from INRS,
- mr. Uwe Kaulbars from HVBG/BGIA,
- prof. Mike Griffin Inst. of Sound and Vibration ISVR,
- dr. Roberto Deboli CNR-IMAMOTER

October 2004 - Mr. U.Kaulbars from HVBG/BGIA and dr. M.Donati from INRS have participated to the meeting of TC-231 in Athens and discussed of the draft norm on grip-push forces, bringing officially the attention on the work that was planned to be done in VIBTOOL. They highlighted how the VIBTOOL project could have a link to ISO/NP-15230 draft norm, which was under development at ISO level. Later, once the project had reached its technical objectives, prof. N.Paone from UNIVPM was invited to the General Meeting of CEN-TC-231 in Warsaw, held in October 2005; to the meeting participated also mr. U.Kaulbars from HVBG/BGIA and mr. M.Donati from INRS. In this occasion prof. N.Paone presented the results of VIBTOOL project and highlighted the possible links to the standard proposal ISO/DIS 15230-”Definitions and guidelines for the measurement of the coupling forces for operators exposed to hand-arm vibrations”. The Resolution 3/2005 taken by CEN/TC 231 on 2005-10-19 says that:

Subject: CEN/TC 231 – VIBTOOL-Project

CEN/TC 231 "Mechanical vibration and shock", — having considered the new information in the presentation of the VIBTOOL-Project by Prof. Paone and having noted ISO/DIS 15230:2005 "Mechanical vibration and shock — Coupling forces at the machine-man interface for hand-transmitted vibration", which has been circulated to ISO/TC 108/SC 4 members for voting by 2006-02-20, decides to ask its members to take into account the results of the VIBTOOL-Project when voting on the DIS. The decision was taken by unanimity.

The interest into the topic brought the partnership to be invited to submit a document to CEN and to National Standardization bodies, with comments on the draft norm, to be used for the voting process that was planned soon after the project end. A number of experimental tests were reported which show a clear correlation between coupling actions and measured vibration level. The example reported here is a series of type tests on chain-saws. It was possible to record time histories of coupling actions on the main handle and on the support handle.



Acceleration was measured by a tri-axial accelerometer. It always was noted a strong correlation between push force and acceleration and between grip force and acceleration, as reported in the pictures below, for the right hand RH and left hand LH.

**Acceleration and RH
Grip, Chain saw**

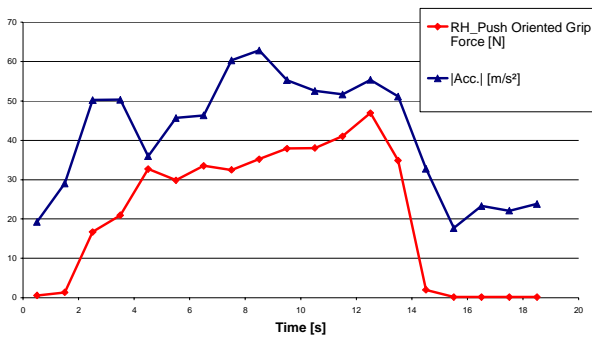

**Acceleration and LH
Push, Chain saw**

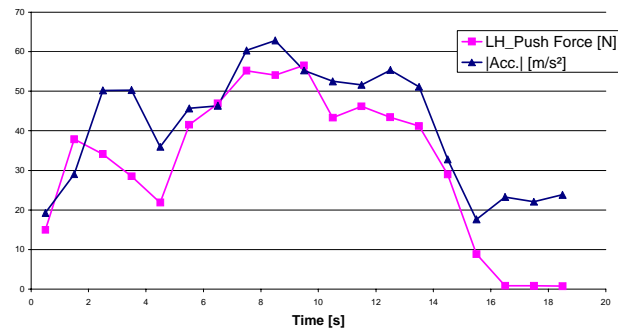

VIBTOOL partners therefore suggest that future norms should prescribe the monitoring of coupling actions during tests, in order to achieve test high repeatability and reproducibility. In fact, vibration measurement results could either be normalized to coupling actions or the test could be validated only if coupling actions stay within a limited range of variation, to be specified. Such an approach is very important to improve repeatability and reproducibility of type tests of tools and of on-field measurement of human exposure to vibration.

The main output in view of standardization can be summarized in the following “Proposal for improvements of the ISO/DIS 15230”, submitted to CEN.

Possible new definitions for PUSH and GRIP

VIBTOOL project has proved that PUSH and GRIP forces can be measured on field by matrices of pressure sensors on real tools. On this basis, improved definitions for PUSH and GRIP can be proposed. PUSH force could be better described as a vector, laying in a plane orthogonal to handle axis; in fact an operator applies a force in space and the proposed definition \vec{F}_{RP} is a real vector quantity which can be measured in the plane orthogonal to the handle axis and would provide information on posture of the operator during the test. VIBTOOL partners therefore propose the following definition as push force:

$$\vec{F}_{RP} = \sum_i P_i \cdot S_i (\cos \alpha_i \hat{i} + \sin \alpha_i \hat{j})$$

where P_i is the pressure applied on the i -th sensor, having area S_i and being located at an angle α_i on the handle, as represented in the figure below.

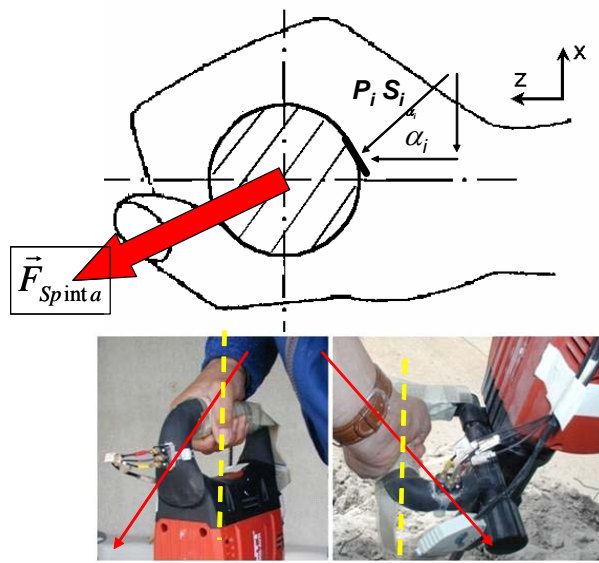

An improved definition for gripping force is also proposed. In fact ISO/DIS-15230 projects the gripping force along an arbitrary direction; indeed gripping action defined as in ISO/DIS-15230 changes value if the direction of projection is changed. The figure below shows the situation.

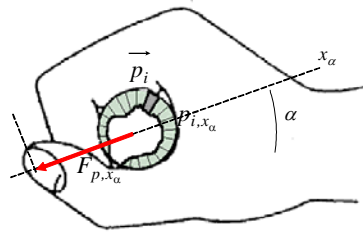

Therefore VIBTOOL partners propose two supplementary definitions; both are based on the projection of the grip action along all possible directions x_{\square} around the handle and on the definition of the projected grip force along x_{\square} as:

$$F_{g\alpha} = \frac{1}{2} \left(\sum_i |\vec{p}_{i,x_{\alpha}}| - F_{p,x_{\alpha}} \right)$$

where x_{\square} is the projection direction, $\vec{p}_{i,x_{\alpha}}$ is the force applied on the i -th sensor, projected along x_{\square} and $F_{p,x_{\alpha}}$ is the push force projected along the direction x_{\square} .

a) the push-oriented grip force $F_{g,pu}$, can then be defined as the grip force $F_{g\alpha}$ computed along the direction of the push vector \vec{F}_{RP} , which may vary during the test, depending on operator posture. The proposed definition is:

$$F_{g,pu} = \frac{1}{2} \left(\sum_i |\vec{p}_{i,x_{\alpha,pu}}| - F_{p,x_{\alpha,pu}} \right)$$

with $x_{\square,pu}$ fixed as the direction of push vector \vec{F}_{RP} .

b) the second proposal is the maximum grip force F_g defined as:

$$F_g = \text{MAX}_{0 \leq \alpha < 2\pi} (F_{g\alpha})$$

Proposed modifications to the text of ISO/DIS-15230

The table below reports a series of proposed modifications to the text of ISO/DIS-15230.

Text from ISO/DIS-15230	Comment / Proposal From VIBTOOL Partners
<p>B.1 General</p> <p>The push or pull, gripping and coupling forces can be calculated from the mapping of local pressure and the geometry of the grip zone. It is essential to know, for each transducer, the relative angle between its surface and the main gripping force axis. The state of art allows to map pressure without interpolation.</p> <p>If the number of transducers is insufficient to cover the whole surface of the hand in contact with the grip zone, it is necessary to make an interpolation between transducers.</p> <p>Experiments have shown the best interpolation to be bi-cubic with a resolution of 1 mm x 1 mm.</p>	<p>B.1 General</p> <p>The push or pull, gripping and coupling forces can be calculated from the mapping of local pressure and the geometry of the grip zone. It is essential to know, for each transducer, the relative angle between its surface and the main gripping force axis. The state of art allows to map pressure without interpolation.</p> <p>If the number of transducers is insufficient to cover the whole surface of the hand in contact with the grip zone, it is necessary to make an interpolation between transducers. Experiments have shown the best interpolation to be bi-cubic with a resolution of 1 mm x 1 mm.</p>
<p>B.2 Push or pull force</p> <p>The push or pull force F_{pu} is calculated as follows (see Figure B.1):</p> $F_{pu} = \sum_i F_{pu,i} = \sum_i F_{c,i} \cos \alpha_i = \sum_i p_i S_i \cos \alpha_i$ <p>(B.1)</p> <p>NOTE When the feed force is not in the direction of the push or pull force, it may be useful to calculate also the resultant forces in this direction.</p>	<p>B.2 Push or pull force</p> <p>The push or pull force F_{pu} is calculated as follows (see Figure B.1):</p> $F_{pu} = \sum_i F_{pu,i} = \sum_i F_{c,i} \cos \alpha_i = \sum_i p_i S_i \cos \alpha_i$ <p>(B.1)</p> <p>NOTE When the feed force is not in the direction of the push or pull force, it may be useful to calculate also the resultant forces in this direction. In this case the following definition of real push force \vec{F}_{RP} should be used:</p> $\vec{F}_{RP} = \sum_i P_i \cdot S_i (\cos \alpha_i \hat{i} + \sin \alpha_i \hat{j})$ <p>\vec{F}_{RP} is a real vector quantity which can be measured in the plane orthogonal to the handle axis and would provide information on posture of the operator during the test. Its direction can be time-dependent.</p>
<p>B.3 Gripping force</p> <p>The gripping force F_{gr} is calculated as follows:</p>	<p>B.3 Gripping force</p> <p>The gripping force F_{gr} is calculated as follows. At first a grip action $F_{g\alpha}$, projected along all possible directions x_α around the handle is computed as:</p> $F_{g\alpha} = \frac{1}{2} \left(\sum_i \vec{p}_{i,x_\alpha} - F_{p,x_\alpha} \right)$

$F_{gr} = \frac{1}{2}(F_{c,p} - F_{pu}) = \frac{1}{2}\left(\sum_i F_{pu,i} - \sum_i F_{pu,i}\right) =$ $= \frac{1}{2}\left(\sum_i p_i S_i \cos \alpha_i - \sum_i p_i S_i \cos \alpha_i\right)$ <p>(B.2)</p> $F_{c,pu} = \sum_i p_i S_i \cos \alpha_i $ <p>(B.3)</p> <p>where $F_{c,pu}$ is the sum of local normal contact forces projected on the push or pull force plane.</p>	<p>where x_a is the projection direction, \vec{P}_{i,x_a} is the force applied on the i-th sensor, projected along x_a and F_{p,x_a} is the push force projected along the direction x_a.</p> <p>Based on this quantity, then:</p> <p>the push-oriented grip force $F_{g,pu}$, is defined as the grip force $F_{g\alpha}$ computed along the direction of the push vector \vec{F}_{RP}, which may vary during the test, depending on operator posture. Its definition is:</p> $F_{g,pu} = \frac{1}{2}\left(\sum_i \vec{P}_{i,x_{\alpha,pu}} - F_{p,x_{\alpha,pu}}\right)$ <p>with $x_{\alpha,pu}$ fixed as the direction of push vector \vec{F}_{RP}.</p> <p>the maximum grip force is defined as:</p> $F_g = \text{MAX}_{0 \leq \alpha < 2\pi}(F_{g\alpha})$
<p>D.2 Pressure measuring instrumentation</p> <p>The measuring system for evaluating the local pressure p_i should correspond to the following recommendations:</p> <ul style="list-style-type: none"> <input type="checkbox"/> minimal ergonomic impairment, <input type="checkbox"/> surface of transducers: not greater than 10 mm x 10 mm, <input type="checkbox"/> thickness of transducers: less than 2 mm, <input type="checkbox"/> range of measurement: up to 1 N/mm², <input type="checkbox"/> minimum resolution: 2 % of the maximum measurement value, <input type="checkbox"/> measurement deviation: lower than 10 % of the measurement value, <input type="checkbox"/> hysteresis: lower than 15 % when loaded and unloaded, <input type="checkbox"/> deviation: lower than 10 % for a constant load applied over a period of 15 min, <input type="checkbox"/> working frequency range: up to 5 Hz, <input type="checkbox"/> deviation: less than 10 % when a tangential effort (30 % of normal force) is applied, <input type="checkbox"/> deviation: less than 30 % when the force is applied on 25 % of the transducer surface. 	<p>D.2 Pressure measuring instrumentation</p> <p>The measuring system for evaluating the local pressure p_i should satisfy the following specifications:</p> <ul style="list-style-type: none"> <input type="checkbox"/> minimal ergonomic impairment, <input type="checkbox"/> individual sensor size: not greater than 11 mm x 11 mm, <input type="checkbox"/> thickness of transducers: less than 2 mm, <input type="checkbox"/> range of measurement: up to 0.3 N/mm², <input type="checkbox"/> minimum resolution: 2 % of the maximum measurement value, <input type="checkbox"/> uncertainty (bias + random): lower than 10 % of the measurement value, <input type="checkbox"/> hysteresis: lower than 15 % of full scale when loaded and unloaded (over a complete cycle from zero to full scale and back), <input type="checkbox"/> drift: lower than 10 % for a constant load applied over a period of 5 min, <input type="checkbox"/> minimum working frequency range: up to 5 Hz, <input type="checkbox"/> sensitivity to tangential loads: deviation less than 10 % when a tangential effort (30 % of normal force) is applied, <input type="checkbox"/> sensitivity to partial loading of a sensor cell: deviation less than 30 % when the force is applied on 25 % of the transducer surface.
<p>D.3 Comparison of different measuring instruments</p> <p>Table D.1 Recommended parameters for</p>	<p>D.3 Comparison of different measuring instruments</p> <p>Table D.1 Recommended specifications for</p>

measuring instrumentation				measuring instrumentation			
	Push or pull force	Gripping force	Pressure		Push or pull force	Gripping force	Pressure
Minimum range of measurement	up to 200 N	up to 100 N	up to 1 N/mm ²	Minimum range of measurement	up to 200 N	up to 200 N	up to 0.3 N/mm ²
Minimum resolution of the maximum value of the measurement range	2%	2%	2%	Minimum resolution of the maximum value of the measurement range	2 %	2%	2%
Working frequency range	up to 5 Hz	up to 5 Hz	up to 5 Hz	Working frequency range	up to 5 Hz	up to 5 Hz	up to 5 Hz
Measurement uncertainty	10%	10%	10%	Measurement uncertainty	± 20% of reading	± 20% of reading	± 10% of reading
Maximum thickness of transducer	10 mm	10 mm	2 mm	Maximum thickness of transducer	2 mm	2 mm	2 mm
Maximum hysteresis	-	-	15 %	Minimum spatial resolution	-	-	11 x 11 mm
				Maximum hysteresis	-	-	15%

Community added value and contribution to EU policies

European dimension of the problem

The project is oriented to Methodologies to support standardisation and Community policies. Document CEN/TC 231/WG2 N 204 "Determination of the measurement uncertainty using the testing methods for vibration emission of hand-held vibrating tools" states the difficulties in having repeatable measurements of tool vibrations and calls for "standardisation of the tool handling". Such request can be satisfied by the development of dedicated sensing systems capable to measure grip pressure distribution between hand and tool. The subject received official endorsement by CEN/STAR and with Resolution CEN/STAR 30/2000 the topic has been included in the list of prioritised research themes. Testing of vibrating hand-held tools is needed in order to qualify tools and to assess compliance to Directive 98/37/EC. The project directly contribute to development of a norm ISO/DIS 15230- "Definitions and guidelines for the measurement of the coupling forces for operators exposed to hand-arm vibrations.

Contribution to developing S&T co-operation at international level. European added value

The questions of health and safety at work have evidently a European dimension, and norms in this field need to be harmonized for an effective realization of EU policies; performing pre-normative research at a European level therefore is mandatory and this Consortium is specifically designed to cover the necessary range of expertise by contributions of the main groups active in contact pressure sensing in hand-arm problems, so to achieve the needed critical mass. The Consortium is really transnational and complementary. The partners are from 5 EU countries and they represent research and academic expertise in the field of measurements of human vibration, together with a sensor company, a tool manufacturer, an occupational health institute.

Contribution to policy design or implementation

The importance at the EU level of this research and its potential impact on standardisation has been explicitly recognized by CEN, through resolution CEN/STAR 30/2000. CEN has in fact decided to endorse research programmes aimed at development of measurement systems for grip force measurement, because such a need is recognized by many studies in this field. The project aims at developing two complementary approaches to measure contact pressure, grip and push force, one based on a matrix of sensors wrapped on a handle, the other based on a set of sensors arranged in a glove; the comparison between the two solutions will provide experimental evidence of which one is more suited to be used in tests. The developments of the project directly contribute to the development of the draft norm ISO/DIS 15230- Definitions and guidelines for the measurement of the coupling forces for operators exposed to hand-arm vibrations

Contribution to Community social objectives

Improving the quality of life in the Community:

Any contribution to reduce health hazards and improve safety at the workplace has a direct social impact and on quality of life. Subjects exposed to vibration will be affected, depending on the exposure level and duration, by a variety of problems, ranging from simple discomfort to stress and to real disease. The major social impact of such research will be related to the improvement of test standards for vibrating tools operated by human beings. This implies that a new generation of safer tools can be developed and that norms related to safety and health

hazards can be more stringent, therefore directly contributing to improve safety and health of workers. A very large number of end-users, that are European citizens, will therefore benefit of the improvement in the performances of the tools. It should be stressed that tools are not only used by professional workers and the number of people using tools at home is increasing.

Provision of appropriate incentives for monitoring and creating jobs in the Community (including use and development of skills):

The project has contributed to develop skills in the EU. In fact, several partners have made use of young researchers and students hired under contract for the development of the activities of the project.

Supporting sustainable development, preserving and/or enhancing the environment (including use/conservation of resources):

The typical environment which is considered in this project is a working environment, where tools are used. Vibrations are known to be a physical agent which is aggressive towards people exposed. This project contributes indirectly to the control and reduction of such a physical agent, which is known to be dangerous. It should also be noticed that reduced vibration usually may imply reduced noise emission; this is important for the urban environment, where often tools are used and are frequently a cause of intense noise emissions. Finally it should be noticed that in general vibrational energy is a typical energy loss, therefore reduced vibrations may imply higher energetic efficiency of tools, therefore reducing energy consumption at a large scale.

Results and Conclusions

VIBTOOL project has extensively explored the topic of indirect measurement of contact forces between hand and handle by use of pressure sensors in the form of matrices to be mounted on the handle and of instrumented gloves that the operator has to wear.

A number of prototypes have been developed and have been characterised metrologically. The glove is a very appealing device, but the tests have shown that it still has limitations due to complexity of localizing the sensors in space; it appears a device suited only for laboratory tests aimed at ergonomic studies. On the other hand the matrices have proven to be a performing device, suited not only for laboratory testing but also for on-field use. In particular the finger-matrix is suited to be mounted also on complex ergonomic handles with limited difficulties.

The partners have then carried out an extensive and deep analysis of the metrological characteristics of the sensors developed, showing that they meet the specifications for measuring contact pressure distributions during tool type tests and during operator exposure tests on field. Both the static and the dynamic response satisfies the specifications.

Partners have developed the algorithms needed to indirectly measure grip force and push force from the spatial pressure distributions measured on the handle. Different models have been used and four definitions have been outlined. They highlight not only the intensity of the action, but also give a vectorial information on push force actions, which is perceived as very interesting for ergonomic studies of hand-arm and tool interaction.

Extensive tests on a large variety of tools (electric, pneumatic and hydraulic) have been performed. The partners have looked on one side to laboratory tests for type testing of tools according to existing norms, on the other side they have looked to field tests for operator exposure measurement. In most cases correlation of acceleration with coupling forces has been highlighted.

Finally, but most relevant, has been the contributions that VIBTOOL partners have made to CEN and ISO, by presenting the project results and their impact on standardization to the annual CEN-TC231 meeting and then by preparing a draft proposal for improvements to the ISO-DIS-15230 standards, which deals with measurement of coupling forces.

This result is relevant because it demonstrates that a project financed under a Dedicated Call for Proposals in Support to Standardization can successfully contribute to the activities of standardization bodies, if properly propelled and if an appropriate common language is used between the research community and the standardization bodies.

References

In the following we report the publications that, at the date of publication of this report, have been done:

1. N.Paone, L.Scalise, **La definizione e la misura delle azioni di presa e di spinta esercitate su di una impugnatura**, Atti del VI Congresso Nazionale di Misure Meccaniche e Termiche, , pp. 1/12-14/12, Desenzano del Garda (BS), settembre 2005.
2. A. Scatigno, **Biomechanical and ergonomic studies of hand-arm vibrations: experimental analysis of an instrumented glove for the mapping of grip and push forces**. Document de travail INRS, IET-NP/05DT-088/So.
3. P. Lemerle, D. Feutry, and L. Claudon, **Design of a New Instrumented Glove for the Measurement of the Contact Pressure Distribution at the Hand/Handle Interface- 10th International Conference on Hand-Arm Vibration**7-11 June 2004, Las Vegas, Nevada, USA.
4. Proposal for the draft standard ISO/DIS 15230 - **Definition and guidelines for the measurement of the coupling forces for operators exposed to hand-arm-vibration**. 2000-03-10.

Acknowledgements

It is acknowledged the stimulus of several actors in the realization of this project, amongst which we feel to explicitly thank:

1. The scientific officer Paolo Salieri, who has followed the project during its first part, has actively motivated and supported the partners to perform their tasks.
2. Dr. Chris Nelson, Convenor of CEN/TC231/WG2-Hand-arm vibration who has actively contributed to the transfer of results to the standardization community.
3. Mr. Dieter Hansen, Secretary of CEN-TC-231 for facilitating the contacts with CEN.